

Industrial Remote Controls

Airmark Series



Installation and User Technical Manual ORIGINAL VERSION

EN

Conductix-Wampfler
10102 F Street
Omaha, NE 68127-1104 USA

Jay électronique - Conductix-Wampfler
Zac la Bâtie rue Champrond
38334 Saint Ismier France



354840C



Doc. ref.:
354840C - EN

Table

1. Service Information	6
2. Introduction	7
3. Product Identification at Delivery	8
3.1. Unpacking Recommendations	8
3.2. Product Identification at Delivery	8
3.2.1. Receiver Output Interfaces	8
3.2.2. Receiver Visual Interface	8
3.2.3. Transmitter Visual Interface	8
4. Product Illustration	9
4.1. Transmitter	9
4.2. Receiver	10
5. Product Operation Principle	11
5.1. General	11
5.2. Main Applications	11
5.3. Operating Modes	12
6. Start up and Use	13
6.1. Receiver Electrical Connection Instructions	13
6.2. Rules of Use and General Precautions	14
6.3. Factory Defaults	15
7. Product Use	16
7.1. Getting Started with Products	18
7.1.1. Powering On	18
7.1.2. Power-on Self-test (default OFF button)	19
7.2. Pairing	20
7.2.1. Primary Pairing	20
7.2.2. Secondary Pairing	20
7.3. Transmitter	23
7.3.1. Stop button	23
7.3.2. Transmitter LEDs	23
7.3.3. Default Signaling	24
7.3.4. Power Supply	24
7.4. Receiver Indicators, Relays, and Outputs	25
7.4.1. Receiver Visual Indicators	25
7.4.2. Internal LEDs	25
7.4.3. Receiver Horn	25
7.4.4. Safety Relay	26
7.4.5. Function Relay Output Assignment	26
7.4.6. Auxilliaries relay output	26
7.4.7. Output Interlock	27
7.5. Operation in Standard Mode	28

7.6.	Operation in Tandem Mode	29
7.6.1.	Startup in Tandem Mode	30
7.6.2.	Pairing One Transmitter to Two Receivers.....	30
7.6.3.	Pairing Three Transmitters with Two Receivers.....	30
7.6.4.	Pairing Two Transmitters and Two Receivers	31
7.6.5.	Auto Release	31
7.6.6.	Voluntary Release.....	31
7.7.	Stopping Products.....	32
7.7.1.	Stopping in Standard Mode	32
7.7.2.	Stopping in Tandem Mode	32
8.	Product Settings	33
8.1.	Access to Settings.....	33
8.1.1.	Setting Entry	33
8.1.2.	In Settings.....	33
8.2.	Discarding a Setting	33
8.3.	Auxiliary Button Configuration (AUX1 + AUX2).....	34
8.4.	Sleep Mode Configuration (F1 + F3).....	36
8.5.	Radio Power Configuration (F1 + F4)	37
8.6.	Start protection and configuration (sequence with F1 – F6).....	38
8.7.	RF Channel Configuration (F1 + F2).....	41
8.7.1.	Fixed Radio Channel Setting	41
8.7.2.	Channel Auto Selection Setting (Aux2).....	42
8.7.3.	Free Channel Startup Setting (F5).....	43
8.7.4.	Channel Agility Setting (F6)	44
8.8.	Receiver Horn Configuration (AUX2 + F1).....	45
8.9.	Passive stop Configuration (AUX1 + AUX2 + F1 + F2).....	47
8.10.	Info & Reset Menu (AUX1 + F4)	49
9.	Specific Tandem Mode Settings	51
9.1.	Receiver Swapping A ↔ B (AUX1 + F5).....	51
9.2.	Release Function (Ungroup) (AUX1 + F3).....	53
9.3.	Sign of Life Between Receivers (F1 + F5)	55
10.	Installation Instructions	57
10.1.	Transmitter	57
10.2.	Radio Receiver Position.....	57
10.3.	Mounting the Receiver	58
10.4.	Antennas	58
10.4.1.	Antenna Type.....	58
10.5.	Connection	59
11.	Maintenance	60
11.1.	Receiver Maintenance	60
11.2.	Transmitter Maintenance.....	60
12.	Warranty	61

13. Technical Specifications	62
13.1. Receiver	62
13.1.1. Dimensions	63
13.2. Transmitter	64
13.2.1. Dimensions	64
13.3. Radio	65
13.4. Battery	65
14. FCC (Federal Communications Commission) Regulations	66
14.1. FCC (Federal Communications Commission) Regulations.....	66
15. Standards and environmental specification	68
16. Recycling and Waste Management	68
17. Manufacturer Information	68
18. Compliance Statement	68
19. Appendix	69
19.1. Radio Frequency Table	69
19.2. Accessories	70
19.2.1. US Version	70
19.2.2. External antenna option	70

1. Service Information

Thank you for choosing the Conductix Wampfler Airmark radio control system that was design with a focus on being a simple affordable system that serves the main application in the overhead crane industry.

If you have any questions regarding the installation or use of the radio control system, please contact our service department "**Customer Service**":

Monday-Friday

Tel: +1-800-521-4888

Email: customer.service@conductix.com

2. Introduction

Our Conductix-Wampfler Airmark radio remote control systems are specifically designed to manage a wide range of industrial equipment and machinery, including overhead cranes, jib cranes, gantries, tower cranes, electric hoists, winches, monorails, conveyor belts, mining equipment, and other wireless handling equipment. Each set consists of two radio control transmitters and a radio control receiver.

Here are some of the notable product specifications:

- **Radio Link:** To ensure safety, the data transmitted between the sender and receiver is protected by Hamming codes and encoded in a manner that prevents any potential threats from a third-party attacker.
- **RF Power:** To avoid interfering with nearby radio connections, the radio emission power between the two devices is regulated to prevent radio spectrum pollution.
- **Radio Channel:** The equipment is fitted with systems that analyze radio signal quality to safeguard against any disruptions caused by the environment.
- **Radio Pairing:** With two-way radio linking, you can pair two pieces of equipment and configure the settings for their use.
- **Reliable Push Buttons:** The push buttons on the transmitter are reliable and have been designed and tested to handle over 500,000 maneuvers.
- **Low Consumption:** The transmitter runs on a standard AA battery.
- **Protection:** The protection class of the transmitter and receiver is IP65.
- **Compliance** – The transmitter and receiver comply with the standards.

3. Product Identification at Delivery

3.1. Unpacking Recommendations

When unpacking the product, do not throw away the supplied labels.

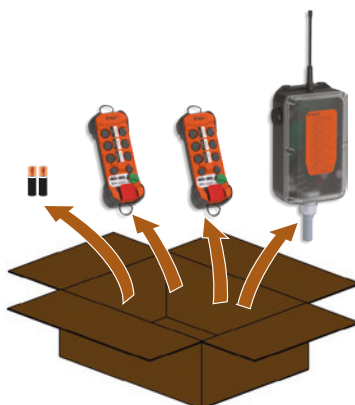

3.2. Product Identification at Delivery

The set consists of the following items:

- Two radio transmitters consisting of 6 function buttons, 2 auxiliary buttons, a rotary **ON/OFF** switch and a red stop button.
- A receiver box, equipped with a wire antenna, horn, internal lamp and output cable allowing connection to the interfaces to be controlled.
- A sheet of identification labels.
- Two AA batteries

3.2.1. Receiver Output Interfaces

- 2 safety relays (safety stop)
- 12 function output relays
- 1 ON relay

3.2.2. Receiver Visual Interface

The receiver is equipped with the following visuals:

- Supply voltage indicator
- Radio link indicator
- White status lamp (receiver free, active, waiting, etc.)
- Horn
- Active safety relay indicator
- Function relay LED.

3.2.3. Transmitter Visual Interface

The transmitter is equipped with the following:

- Battery charge level indicator
- Radio transmission indicator
- Four selection position indicators (LEDs A, B, C, and D).

4. Product Illustration

4.1. Transmitter

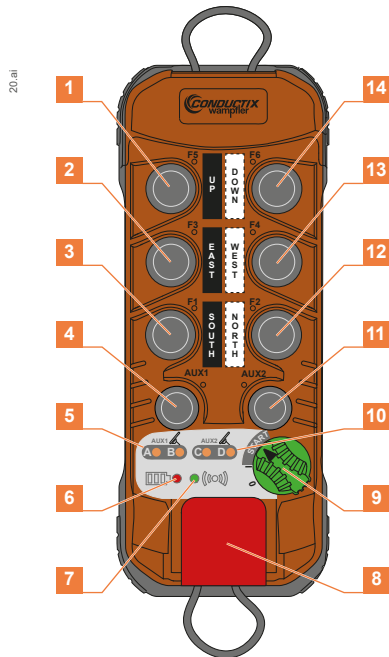

Front Face

- | | |
|---------------------------------|---|
| 1 F5 double speed button | 8 Stop button |
| 2 F3 double speed button | 9 ON/OFF switch <ul style="list-style-type: none"> • position 0 = OFF • position I = ON • position START = Validation |
| 3 F1 double speed button | 10 Amber LEDs C and D |
| 4 Push button AUX1 | 11 Push button AUX2 |
| 5 Amber LEDs A and B | 12 F2 double speed button |
| 6 Red "battery" LED | 13 F4 double speed button |
| 7 Green radio LED | 14 F6 double speed button |

Rear Face

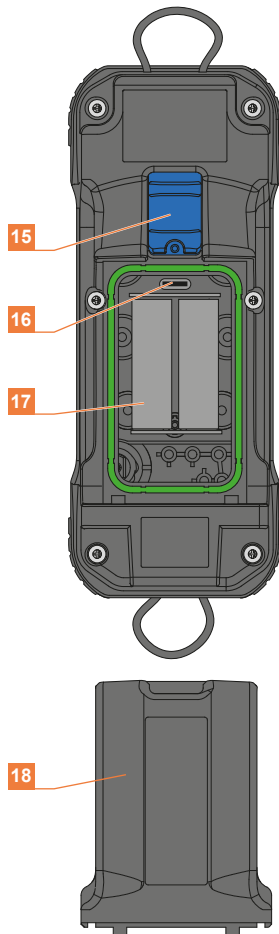

- | | |
|------------------------------------|-------------------------------------|
| 15 Battery compartment lock | 17 2 AA batteries |
| 16 USB-C plug | 18 Battery compartment cover |

4.2. Receiver



Front Face

- 1** RF Antenna
- 2** Indicator LEDs
- 3** Built-in Horn
- 4** Transparent Cover with Wiring Label
- 5** Cable Gland
- 6** Numbered Wires
- 7** Built-in White Lamp

5. Product Operation Principle

5.1. General

This set includes a wireless command receiver and a transmitter that communicate with each other in both directions. The transmitter sends commands to the receiver, decodes them, and activates relay outputs based on the settings.

5.2. Main Applications

- Standard Crane: 3 motion 2 or 1 speed.
Aux 1 and Aux 2 functions available with 3 wire hoists.

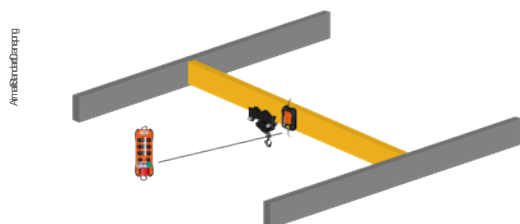

- Auxiliary Hoist: 4 motion 2 or 1 speed.
Aux 1 function still available.

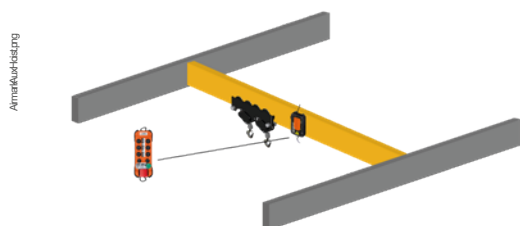

- Tandem Trolley: 5 motion 2 or 1 speed.
Aux 2 functions still available.

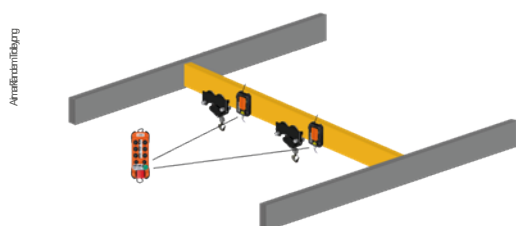

- Tandem Crane: 6 motion 2 or 1 speed.
Aux 2 function still available.

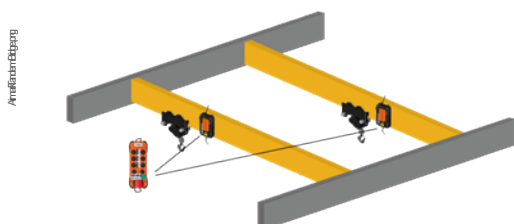

5.3. Operating Modes

Airmark range products can operate in three distinct control modes.

- Standard: a transmitter and a receiver that communicate over a radio channel

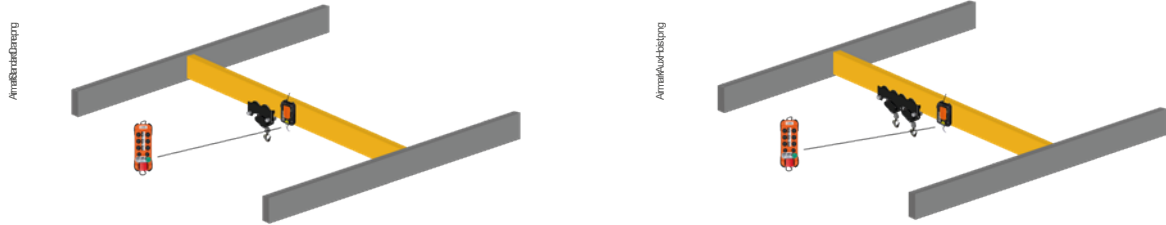

- Tandem: with three versions
 - a transmitter and two receivers that communicate over a radio channel

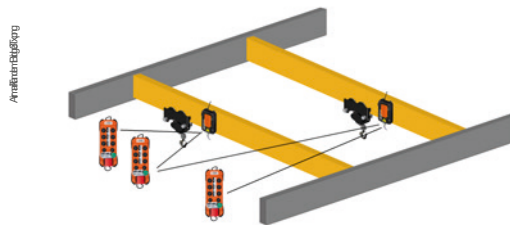

- Tandem/Tandem
 - two tandem transmitters can control either or both receivers.

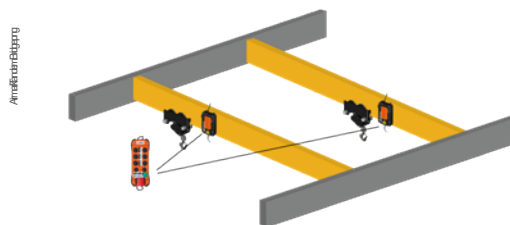

- Tandem/Dedicated
 - single transmitter that can control either or both receivers. Dedicated transmitters that only control cranes A and B individually.

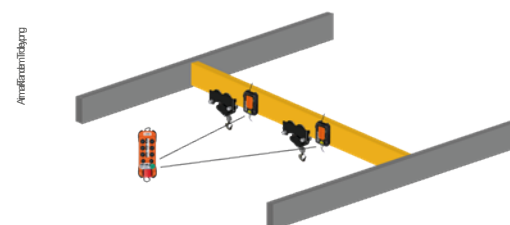

6. Start up and Use

6.1. Receiver Electrical Connection Instructions

IMPORTANT:

IF THE TRANSCEIVER IS POWERED DIRECTLY FROM THE DISTRIBUTION NETWORK, THE "IT" TYPE ELECTRICAL DISTRIBUTION DIAGRAM CANNOT BE USED FOR THE TRANSCEIVER POWER SUPPLY



A trained and authorized professional must carry out the electrical installation.



To avoid any risk of electrocution, never open the receiver module's housing when powered on. To access the inside of the receiver module, it is essential to ensure that the power supply cables and control cables are powered off.



The receiver's power supply circuit must be directly connected to the equipment's power supply to be radio-controlled. The receiver module's power supply must have a suitable separation medium (fuse(s) or circuit breaker) or use the one from the equipment to be radio-controlled.



Installation must comply with mechanical and fire insulation rules under the standard in the country of use.



In the cable tray, it is advisable to separate the power cables from the control cables, respecting a minimum spacing (20 cm) between the different classes:

- **Class 1:** Radio, analog signals
- **Class 2:** Mains for supplying power to various elements
- **Class 3:** Power control of motors, drives, etc...

If only one cable path is available, cables of different classes must be separated as much as possible.

6.2. Rules of Use and General Precautions

A radio-control system is considered as a control device.
Its proper implementation must comply with resulting rules.

The system allows the operator to focus their attention on their work by choosing the place of observation limited only by safety requirements (e.g.: not parking under a suspended load).

The radio-control system does not eliminate but completes the classic safety circuits (e.g.: emergency stops).



To ensure safe use, following the instructions in this manual is essential.



The user must be trained and authorized to drive by radio control.



The user must maintain visibility of the maneuver they perform at all times. When the direct field of vision is insufficient, the controlled equipment must be fitted with auxiliary devices to improve visibility.



In the event of simultaneous movements of several pieces of equipment, these pieces must be fitted with means to reduce the consequences of a possible collision.



To avoid any risk of electrocution, never open the receiver module's housing when powered on. The housing must be opened by ensuring that the power supply cables and control cables are powered off.



Do not leave the transmitter in any location even though it has an automatic shutdown feature called "Standby".



To maintain the reinforced insulation inside the receiver housing, it is mandatory to increase the insulation of cables carrying high voltages with insulating sleeves.



Do not leave the transmitter in the sun (e.g. vehicle windshield), or near a heat source.



If several radio-control systems are used at the same site, working with different radio frequencies is advisable. We recommend at least one channel separation between adjacent systems.



In the event of an anomaly, immediately stop the installation by pressing the transmitter Stop button and remove the batteries.



Maintain the equipment, and carry out periodic checks, depending on the intensity of use. Following the cleaning instructions described in Chapter **"Maintenance"**, page 60 is essential.











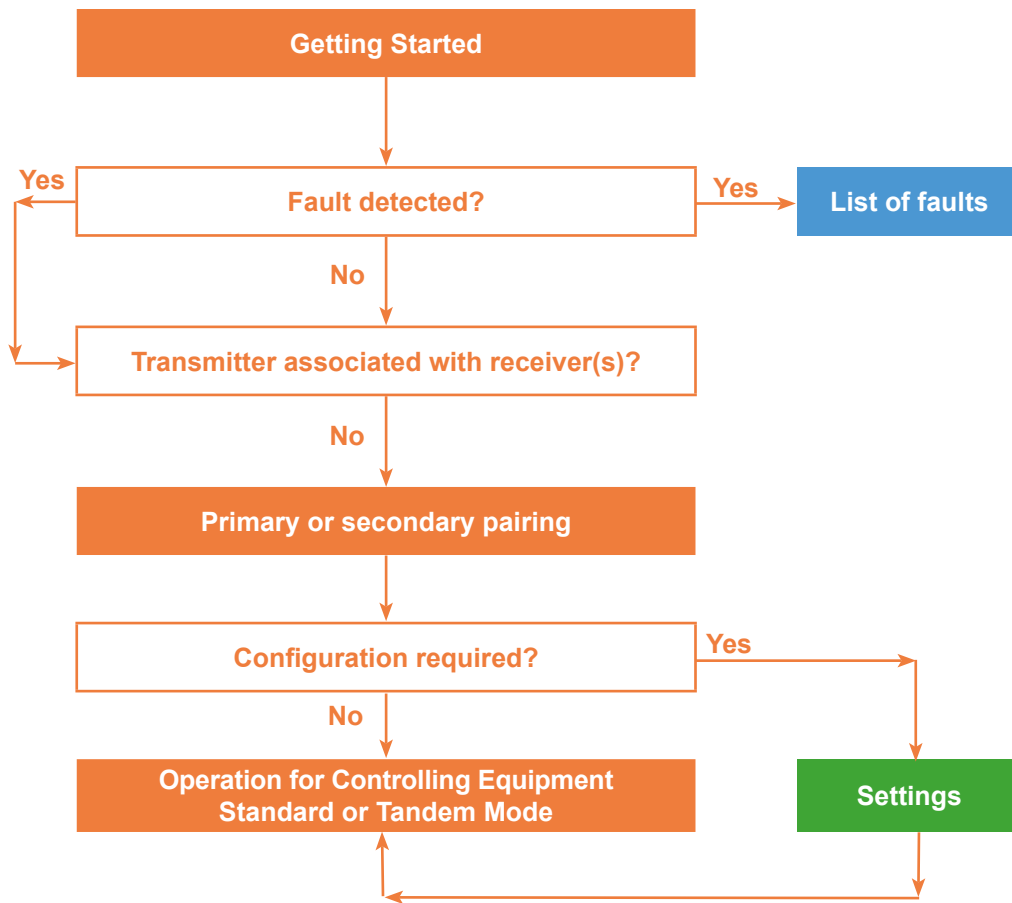





















Take all possible precautions so that a malevolent intelligence equipped with a means of listening and reproducing radio exchanges cannot impersonate the transmitter associated with the receiver and take control of the installation.

6.3. Factory Defaults

- A fixed radio channel is automatically assigned
- Radio power is set to automatic power regulation
- Standby is set to 5 minutes
- Horn is set to sound level 2, automatic pattern (the pattern depends on the channel)
- Without start-up protection sequence
- Passive stop delay is set to 0.5 seconds
- In automatic release mode and active sign-of-life mode
- Aux1 and Aux2 set to momentary control (Rsel_1 and Rsel_2 at 0)

7. Product Use



7. Use of Products	   
7.1. Getting Started with Products	
7.2. Pairing	
Primary Pairing (AUX1 + F1)	off   (x1)
Secondary Pairing (AUX1 + F2)	off   (x2)
7.3. Transmitter UI	
7.3.3. Default Signaling	
7.4. Receiver Indicators, Relays, and Outputs	
7.5. Operation in Standard Mode	
7.6. Operation in Tandem Mode	
7.7. Stopping Products	
8. Product Settings	
8.1. Access to Settings	
8.2. Discarding a Setting	
8.3. Auxiliary Button Configuration (AUX1 + AUX2)	off   (x3)
8.4. Sleep Mode Configuration (F1 + F3)	off   (x5)
8.5. Radio Power Configuration (F1 + F4)	off   (x6)
8.6. Protection Sequence Configuration (code with F1 – F6)	off   (x7)
8.7. RF Channel Configuration (F1 + F2)	off   (x8)
8.8. Receiver Buzzer Configuration (AUX2 + F1)	(x1)   (x1)
8.9. Passive Stop Configuration (AUX1 + AUX2 + F1 + F2)	(x1)   (x2)
8.10. Info & Reset Menu (AUX1 + F4)	(x1)   (x3)
9. Specific Tandem Mode Settings	
9.1. Receiver Swapping A ↔ B (AUX1 + F5)	off   (x4)
9.2. Release Function (Ungroup) (AUX1 + F3)	off   (x9)
9.3. Sign of Life Between Receivers (F1 + F5)	(x1)   off

7.1. Getting Started with Products

7.1.1. Powering On

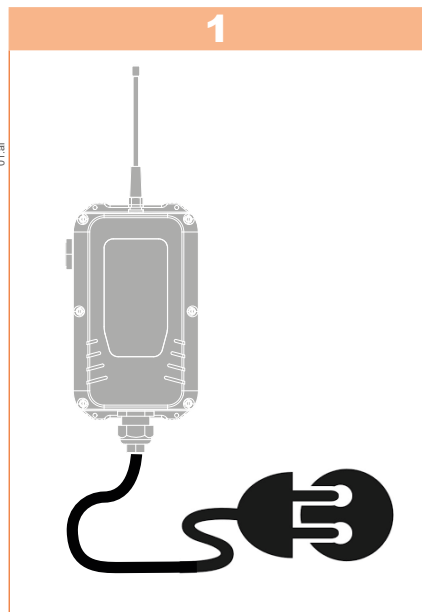

Power up the receiver, the amber power LED lights up.

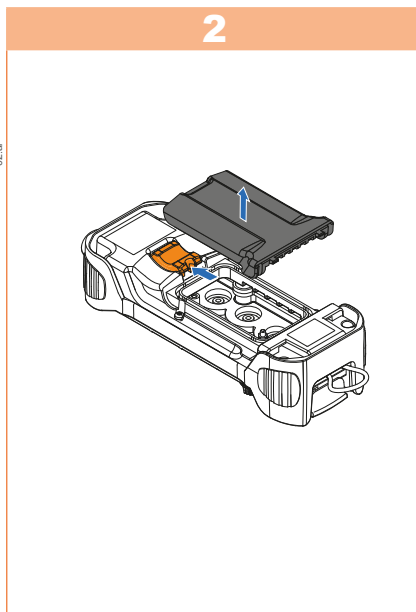

Insert two AA batteries into the back of the transmitter.

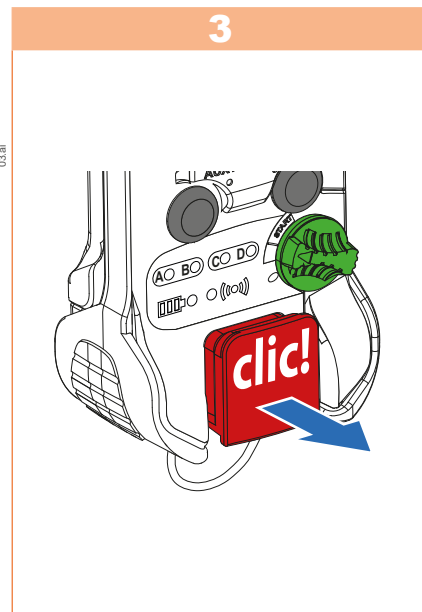

Unlock the transmitter by lifting the Stop button.

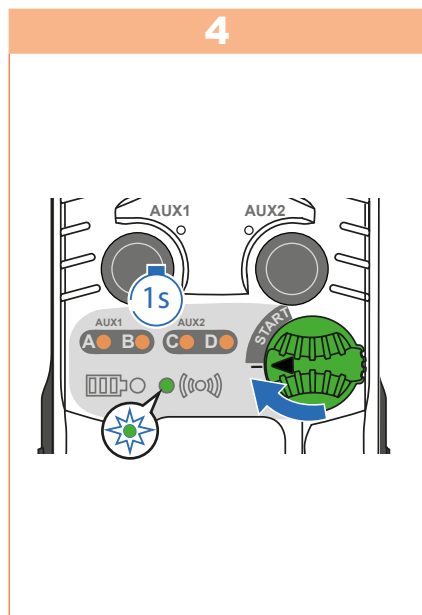

Start the transmitter by turning the **ON/OFF** switch to **I (ON)**⁽¹⁾. LEDs A, B, C, and D light up for 1 sec (initialization phase and self-test).
If there is no fault:

- The battery LED indicates the charge level
- The radio LED is continuously on.

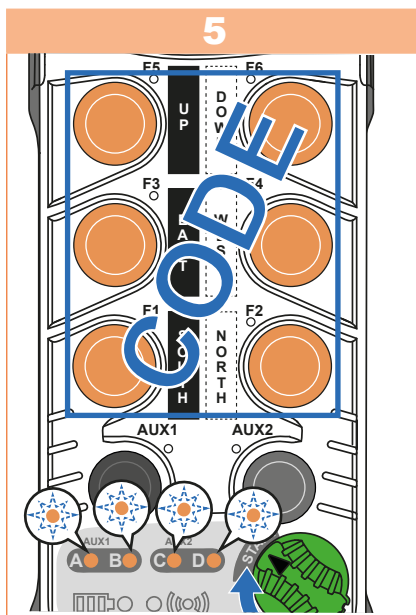

If LEDs A, B, C, and D flash at the same time, the transmitter is locked by a protection sequence. Re-enter the sequence (buttons **F1-F6**) and validate by turning the **ON/OFF** switch to **START**.
If the code is correct, initialization starts (the green LED lights up for 2 sec).

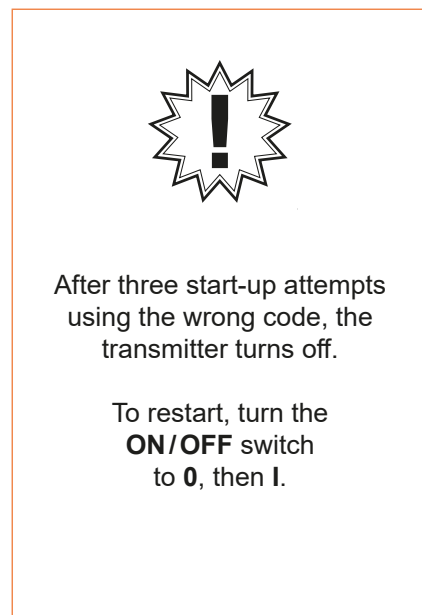

(1) If the **ON/OFF** switch is turned from **0** to **I** without unlocking the Stop button, LEDs A, B, C, and D are on steady and the battery and radio LEDs flash alternately. A 20 second delay is enabled while waiting for unlock.

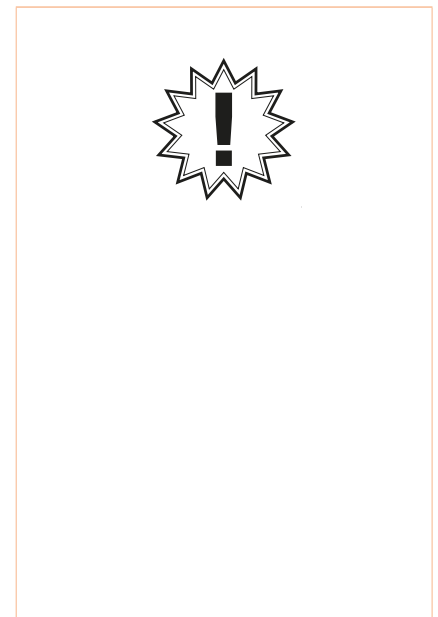
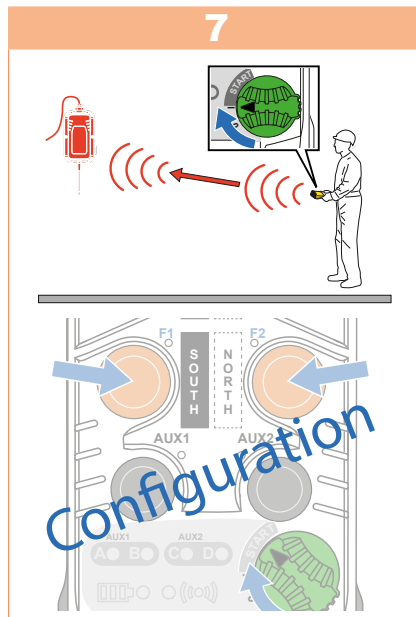
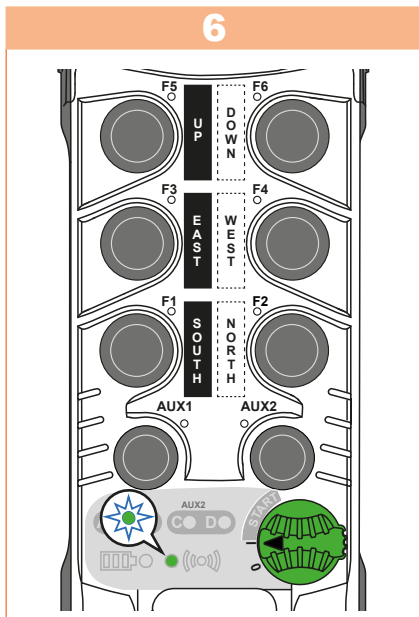

After successful initialization and if products have been configured:

- The radio LED is continuously on
- The battery LED indicates the charge level
- LEDs A and B resume the previous start status if AUX1 is selector mode. If latching mode, LED A blinks before start and LED B is off. For other cases, the LEDs A and B are off.
- LEDs C and D resume the previous start status if AUX2 is selector mode. If latching mode, LED C blinks before start and LED D is off. For other cases, the LEDs C and D are off.

- To start the radio link, turn the **ON/OFF** switch to **START**
- Or to go to product configuration, activation 2 buttons and turn the **ON/OFF** switch and **START** switch at the same time.

In the event of initialization failure or when a fault appears on the transmitter, this is indicated by the various LEDs on the interface. For the fault type, refer to Chapter **7.3.3**.

7.1.2. Power-on Self-test (default OFF button)

After the transmitter is powered on (**ON/OFF** switch in position I), the buttons' OFF status is automatically checked.

If an error is detected (if one or more F1-F6, AUX1, AUX2 buttons remain pressed), the battery and radio LEDs flash simultaneously and the transmitter cannot be used.

7.2. Pairing

During a pairing, the transmitter and receiver exchange application settings and the radio channel over which they will communicate.

The procedure for a primary or secondary pairing is similar, only the mode selection (step 1) and corresponding visual indication differ.

Pairing Type	Access to Configuration Mode (via transmitter interface)	Visual Indication
Primary	AUX1 + F1	off ● ● (x1)
Secondary	AUX1 + F2	off ● ● (x2)

Products must be ready for configuration (if the transmitter and receiver are not powered on and unlocked, perform the steps in Chapter 7.1).

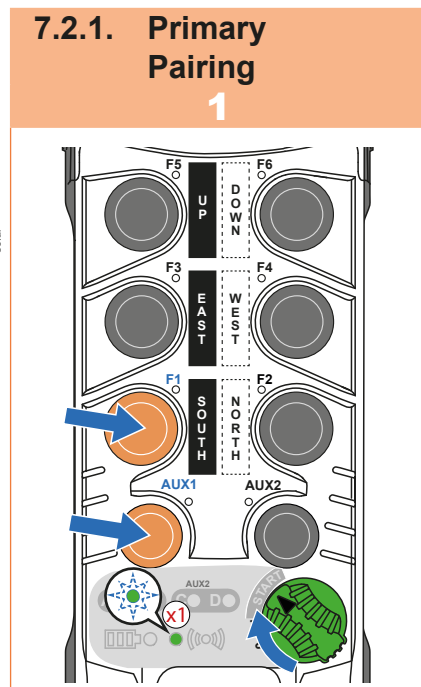

Press and hold the **AUX1** and **F1** buttons and turn the **ON/OFF** switch to **START**:

- The battery LED turns off
- The radio LED flashes **1** time.

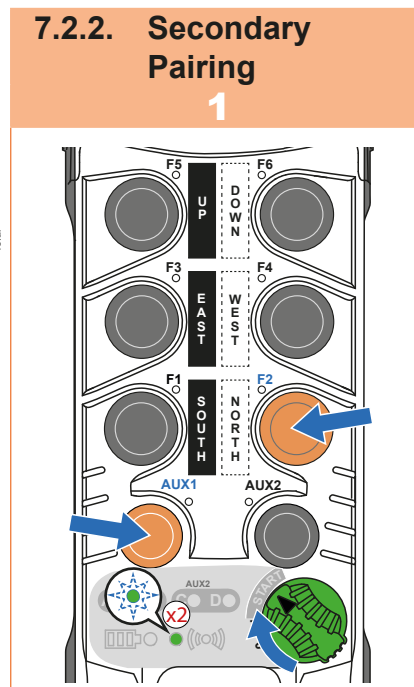

Press and hold the **AUX1** and **F2** buttons and turn the **ON/OFF** switch to **START**:

- The battery LED turns off
- The radio LED flashes **2** times.



A receiver can only be set up by the main pairing transmitter.



Pairing a second receiver automatically enables the operating mode with 2 receivers. The Aux1 button becomes a bridge selector which is set to selection mode A / B / A +B by default.

Steps 2-8 are the same for primary or secondary pairing.

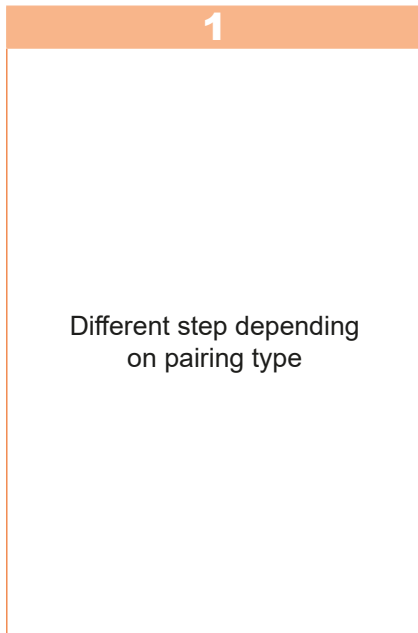

Primary Pairing: simultaneously press **AUX1 + F1**.
Secondary Pairing: simultaneously press **AUX1 + F2**.
 Then, press and hold the 2 buttons, turn the **ON/OFF** switch to **START**.

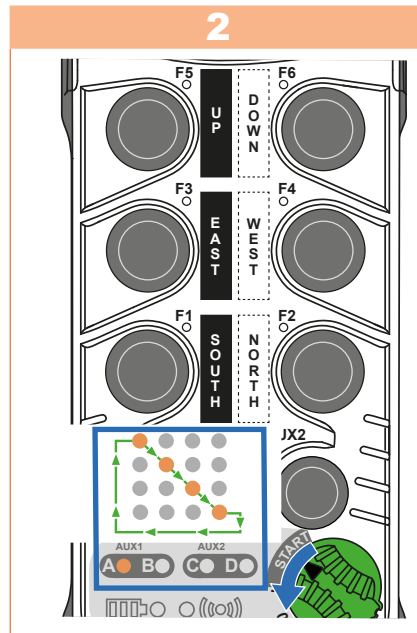

Release the **ON/OFF** switch to start pairing:
 LEDs A, B, C, and D light up one after the other to indicate that a receiver search is in progress.

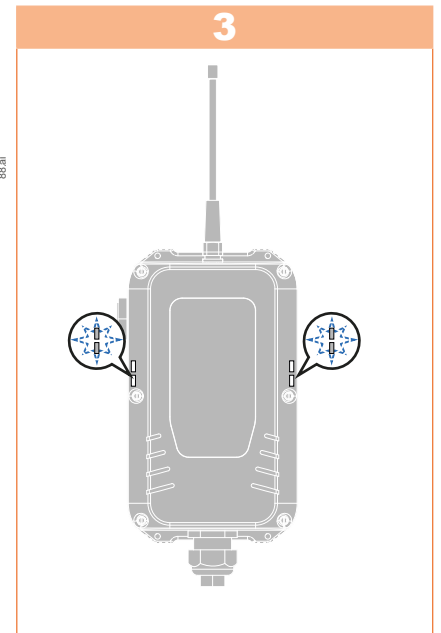

When a receiver is found, the lights flash quickly to indicate it has been selected and is ready for pairing.

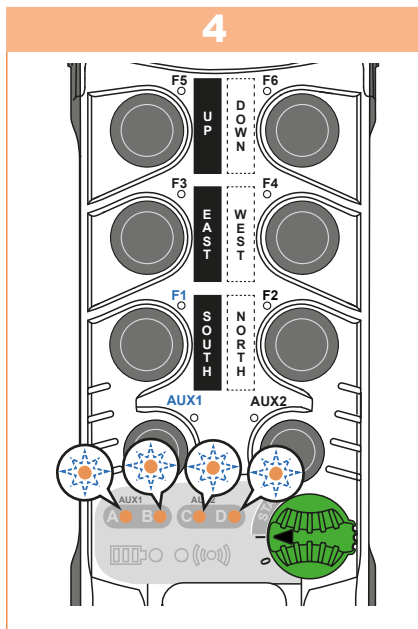

When receivers have been found, LEDs A, B, C, and D on the transmitter flash quickly.

! Note: If no receivers are found, the battery LED lights up and the radio LED is off.

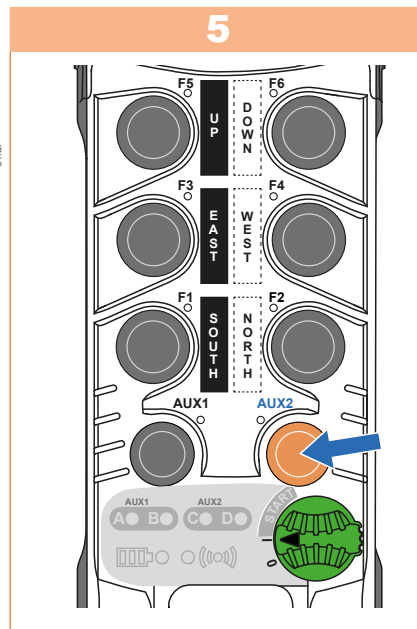

If several receivers have flashing white lights, it is possible to switch from one to the other by pressing the **AUX2** button: the preselected receiver is the one whose light flashes quickly.
 Once the correct receiver is flashing, turn the **ON/OFF** switch to **START** to select the receiver.

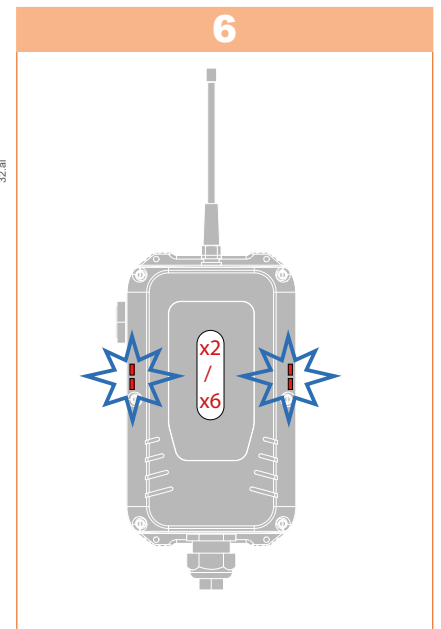

Wait for the receiver's built-in white light to flash quickly: from 2-6 periodic quick flashes.
 Count the number of flashes.

! The lights of other powered receivers within the same area may also flash slowly.

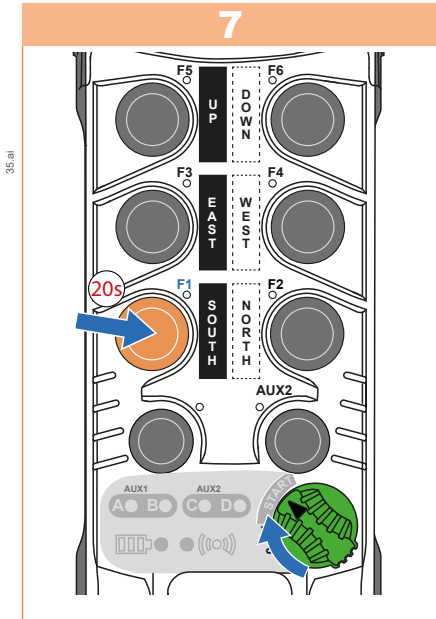

Within **20 sec**, press the **F1** button as many times as the number of receiver flashes.

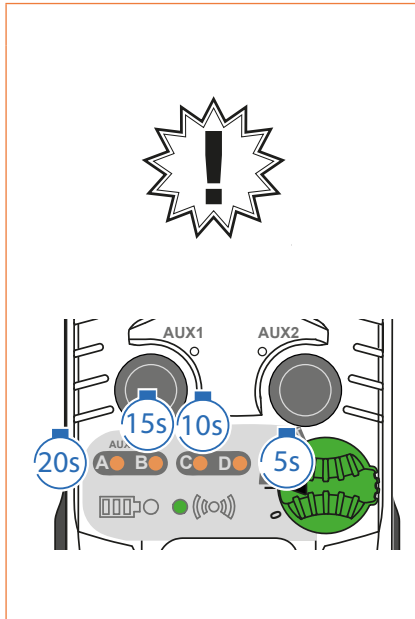

LEDs A, B, C, and D indicate the remaining time by turning off successively every 5 sec in reverse alphabetical order: D after 5 sec, C after 10 sec, B after 15 sec, and A after 20 sec.



If the receiver **does not** receive the ID code within **20 sec** following switching the **ON/OFF** to **START**, the receiver aborts the pairing.

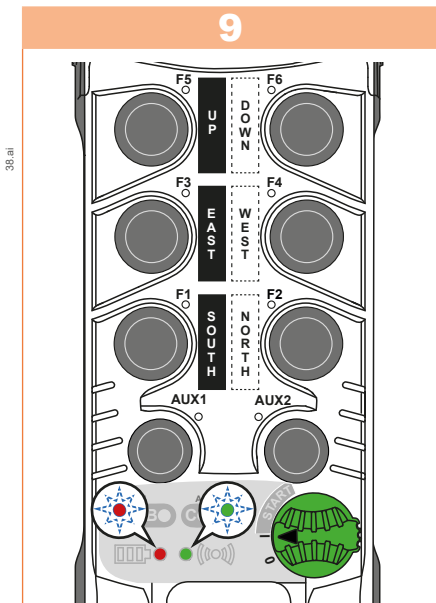

- End of procedure:
- Battery and radio LEDs flash alternately.
 - The receiver's white built-in light turns on for 2 sec
 - And the products restart.

Each product knows the ID of one another, as well as the working channel.

It is possible to pair a second transmitter (spare). To do so, follow the pairing procedure described in this paragraph. When the pairing of the second transmitter is done, the receiver knows that two transmitters are authorized to operate separately with the receiver.

If a third transmitter is paired to the same receiver, the last transmitter that started the receiver is retained and the second transmitter is replaced by the new one.

7.3. Transmitter

7.3.1. Stop button

The transmitter is equipped with a Stop Button. This button must be unlocked before turning the **ON/OFF** switch to I, otherwise the transmitter cannot be used.

To ensure that the Stop button works properly, the button must be tested once per year.

7.3.2. Transmitter LEDs

The transmitter is equipped with the following visual indicators:

- Power indicator (“battery”)
- Radio indicator
- Two indicators, A and B, for the AUX 1 button
- Two indicators, C and D, for the AUX 2 button.

7.3.2.1. Battery Indicator (red LED)

The red battery LED indicates the charge level. This level is visible after the transmitter is powered on (**ON/OFF** switch on I) or during operation of the radio control (radio transmission between the transmitter and the receiver). The table below shows the correspondence between LED status and the charge level of the transmitter:

Transmitter Status	Red “Battery” LED Status	Charge Status
Powering On	Always OFF	Battery charge is > 90%
	Flashes once periodically	Battery charge is between 10% and 90%
	Flashes quickly	Battery charge is < 10%
Operating	Always OFF	Battery charge is > 10%
	Flashes quickly	Battery charge is < 10%



When the battery charge level is less than 10%, batteries must be replaced.

7.3.2.2. Radio indicator (green LED)

This visual indicator shows the status of the transmitter: powering it up or using it in radio communication:

Transmitter Status	Radio green LED status	Description
Powering On	Always ON	Transmitter ON
Operating	Flashes regularly	Transmitter during radio transmission

7.3.2.3. AUX Button Indicator

Each AUX1 or AUX2 button can be assimilated, depending on its configuration:

- to a 3-position or 2-position function switch
- or a latching control
- or a momentary control

Button configuration changes from one type to another each time the corresponding AUX button is pressed and is indicated by a pair of two LEDs:

- LEDs A and B for the AUX1 button
- LEDs C and D for the AUX2 button.

When the transmitter is powered on, LEDs A, B, C, and D light up briefly during the initialization phase (2 sec).

If the button AUX1 is configured in tandem selector, the indicator position A / B correspond to the last position saved before start performed previously. For latching configuration of the button AUX1, the LED A blink previously start and light up if the relay Aux is closed.

For indicator C / D the comportment is the same that previously, depending on the configuration of AUX2 button.

Button configurations can be changed by setting, refer to Chapter 8.3 for details.

7.3.3. Default Signaling

When a fault appears on the transmitter, it is signaled via the various LEDs on its interface.

Transmitter LED Status	Description
The battery LED and radio LED flash alternately	Stop button locked
The battery LED and radio LED flash simultaneously	Default buttons (F1 to F6, AUX1, AUX2) (remain pressed)
LED A or B flashes 5 times and the battery LED turns on	Transmitter/receiver link fault

7.3.4. Power Supply

The transmitter is equipped with 2 AA batteries. They are placed in the back slot of the transmitter.

7.4. Receiver Indicators, Relays, and Outputs

7.4.1. Receiver Visual Indicators

The receiver has 3 internal status LEDs, these are used to indicate the following statuses:

- Orange power LED: indicates that the receiver is ON
- Green radio LED: indicates that the receiver is communicating with a transmitter
- Red diagnostic LED: indicates default statuses.

The receiver also has a light that is visible through the transparent cover. This allows you to see different operating phase statuses of the receiver:

Light Status	Safety Relay Position	Description
Light is OFF	Open	Receiver is free ("Tandem" mode)
Light is ON	Closed	Receiver is communicating with a transmitter
Light flashes once periodically	Open	Receiver is being used by one of the transmitters in "Tandem" mode
Light turns off once periodically	Closed	Receiver is being used by one of the transmitters in "Tandem" mode, but is not selected by the AUX1 switch
Light flashes continuously	Open	Receiver has entered pairing mode, and is waiting for a transmitter to pair
Light flashes quickly	Open	Pairing or configuration is in progress

7.4.2. Internal LEDs

These internal LEDs are visible when housing is open:

- One LED per function output which reflects the status of the function relay (red if relay is closed)
- One LED for the two safety relays which reflects the status of the safety relays (red if relay is closed)
- One power supply presence LED (amber)
- One radio LED which reflects the quality of radio reception (green)
- One fault LED which lights up if a fault is detected (red).

7.4.3. Receiver Horn

The receiver is equipped with 1 horn. This horn is activated for at least 2 sec when the start lever is activated and as long as it remains active.

7.4.4. Safety Relay

The receiver is equipped with 2 safety relays.

The two safety relays are active in operation as soon as the link is established between the transmitter and the receiver, as long as an active stop has not been received.

7.4.5. Function Relay Output Assignment

Function relay outputs are assigned to function buttons as shown below:

Function Buttons	K1 Relay	K2 Relay	K3 Relay	K4 Relay	K5 Relay	K6 Relay	K7 Relay	K8 Relay	K9 Relay	(K13)
F1 - 1	■									
F1 - 2	■		■							
F2 - 1		■								
F2 - 2		■	■							
F3 - 1				■						
F3 - 2				■		■				
F4 - 1					■					
F4 - 2					■	■				
F5 - 1							■			
F5 - 2							■		■	
F6 - 1								■		
F6 - 2								■	■	
BPON = Start										■

■ = active relay Kx represents the physical designation of the relay on the board

7.4.6. Auxilliaries relay output

The selector relay outputs are assigned to the position selectors of the transmitter in several ways depending on the saved setting.

7.4.6.1. AUX1 Function

Setting Switch 1	AUX Relay Behavior (K10)
Momentary control	Closed when Aux1 button is active
Latching control	Every time the Aux1 button is pressed, the relay status changes (closed ↔ open)

In Tandem mode, the Aux relay statuses are as follows:

- When AUX1 button is positioned on A+B, the Aux Relay is always ON.
- In position A or B, the Aux Relay can be activated during 30 sec if there is at least one button press in first position and momentarily the **ON/OFF** switch has been push to **START**. The relay's hold time is reactivated as soon as a button is pressed in the first speed. The Aux Relay is deactivated as soon as a button is pressed in the second speed.

7.4.6.2. AUX2 Function

Setting Switch 1	Aux 2-1 Relay Behavior (K11)	Aux 2-2 Relay Behavior (K12)
Momentary control	ON when AUX2 auxiliary button is active	Reverse of relay Aux 2-1 (K11)
Latching control (C/0)	Each time the AUX2 button is pressed, the relay status changes (OFF ↔ ON)	Reverse of relay Aux 2-1 (K11)
2 Position Selector Mode (C/D)	Pos 0: OFF Pos 1: ON	Reverse of relay Aux 2-1 (K11)
2 Position Selector Mode (C/D/C + D)	Pos 0: ON Pos 1: OFF Pos 2: ON	Pos 0: OFF Pos 1: ON Pos 2: ON
3 Position Selector Mode (C/D/0)	Pos 0: ON Pos 1: OFF Pos 2: OFF	Pos 0: OFF Pos 1: ON Pos 2: OFF

Note: When the safety relays are open, the relay Aux1, Aux 2-1 and Aux 2-2 have the compartments below:

AUX1 correlation table after a Stop button

Modes	State of Aux1 Relay
Momentary control A	Open
Latching A / 0	Maintains its state
Selection A / B	Open
Selection A / B / A + B	
Selection A	
Selection B	
Selection A + B	

AUX2 correlation table after a Stop button

Modes	State of Aux 2-1 and Aux 2-2 Relays
Momentary control C	Aux 2-1 Open Aux 2-2 Closed
Latching C / 0	Maintains their states
Selection C / D	Open
Selection C / D / C + D	
Selection C / D / 0	

7.4.7. Output Interlock

Interlocks are set by factory. Pressing two function buttons in the same row disables the two function button commands.

Below are cases of interlocks that place output relays in the OFF state.

	K1 Relay	K2 Relay	K3 Relay	K4 Relay	K5 Relay	K6 Relay	K7 Relay	K8 Relay	K9 Relay
K1 Relay	NA	N							
K2 Relay	N	NA							
K3 Relay			NA						
K4 Relay				NA	N				
K5 Relay				N	NA				
K6 Relay						NA			
K7 Relay							NA	N	
K8 Relay							N	NA	
K9 Relay									NA

N = Relay OFF NA = Not Applicable

When an interlock is active, the control function common relay is also turned OFF. Cases are as follows:

- Interlock K4/K5, so K6 = OFF
- Interlock K7/K8, so K9 = OFF
- Interlock K10/K11, so K12 = OFF.

7.5. Operation in Standard Mode

For a transmitter to start a receiver, the products must be paired first. Each product has its own ID code, and each knows the code of its contact.

These ID codes allow identification with the recipient of the message.

Products must be ready (if the transmitter and receiver are not powered on and unlocked, perform the steps in Chapter 7.1).

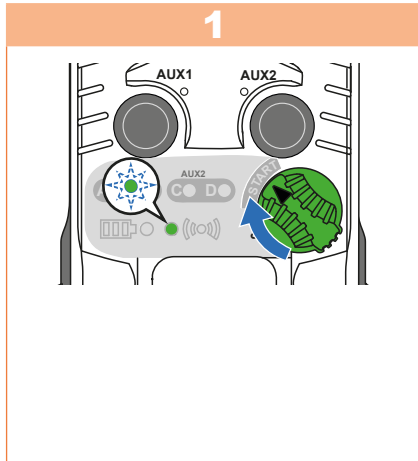

Turn the **ON/OFF** switch to the **I** (ON) position.
Ensure the LEDs A through D turn on and then off.
Then turn the **ON/OFF** switch to **START** to start the radio linking:

- The radio LED flashes
- The receiver's safety relays are active.

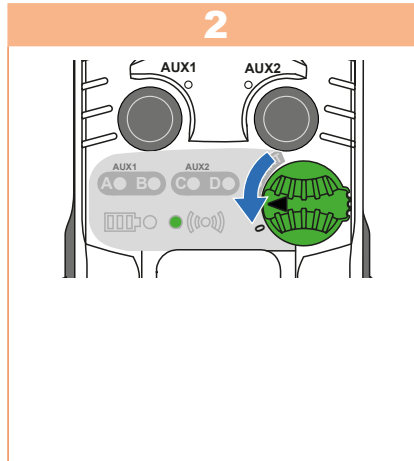

Release the **ON/OFF** switch.

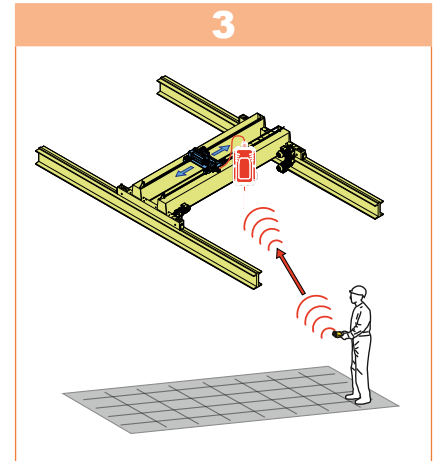

Use the remote control to operate your equipment.

7.6. Operation in Tandem Mode

This feature makes it possible to control two devices synchronously with a single transmitter and two receivers (one main and one secondary).

The AUX1 auxiliary button on the transmitter is used to select the control type: Independent operation (standard mode one transmitter and only one of the two receivers) or operation of the two associated receivers at the same time:

■ Tandem mode one transmitter (TxA) with two receivers (RxA and RxB)

The AUX1 auxiliary button on the transmitter is used to select the operating modes: Dedicated mode (standard mode one transmitter and only one of the two TxA-RxA or TxA-RxB receivers) or tandem mode for control of the two associated receivers at the same time (TxA - RxA + RxB).

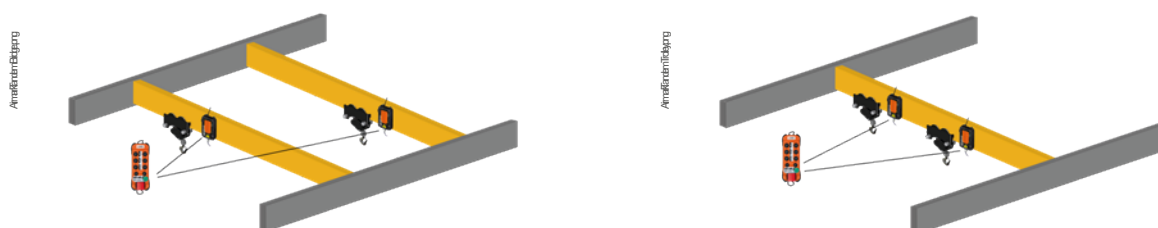

■ Tandem/Dedicated mode 3 transmitters (TxA, TxB, TxC) and two receivers (RxA, RxB)

In this configuration one transmitter TxC is set for tandem control. It can operate either or both RxA and RxB. TxA and TxB are in dedicated mode and can only operate RxA and RxB respectively.

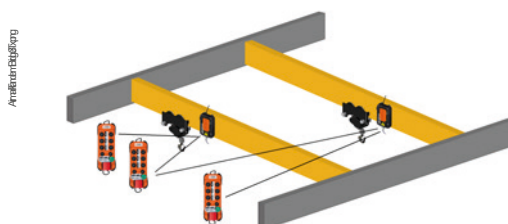

■ Tandem mode two transmitters (TxA, TxB) and two receivers (RxA, RxB)

In this configuration, the TxA transmitter will be previously associated with the RxA receiver (primary pairing) and then associated with the secondary receiver RxB in the vicinity (secondary pairing). By symmetry, the TxB transmitter will have RxB as the primary receiver, while RxA will be the secondary receiver.



Pairing the second receiver automatically activates the operating mode with 2 receivers. The Aux1 button then becomes a bridge selector. By default, this is set to selection mode A/B/A + B.



The RxA or RxB receiver can only be set by the primary pairing transmitter.

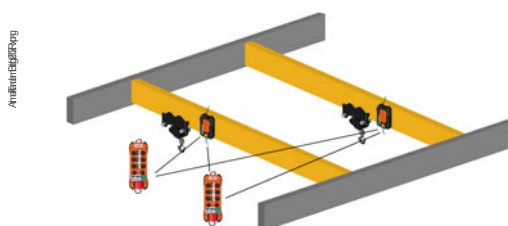

The AUX1 button can be configured and its configuration is indicated by the pair of LEDs A and B, refer to Chapter 8.3 for details.

7.6.1. Startup in Tandem Mode

In order to start in tandem mode, both receivers must be “free” that is, they are in safety mode and listening to the primary transmitter and neighboring transmitter.

To start in Tandem mode, follow the three steps below:

- Switch on the products: follow the instructions described in Chapter 7.1.
- When starting in Tandem mode, check that the AUX1 button is set to selection A+B (LEDs A and B continuously ON). Otherwise press the AUX1 button as many times as necessary to reach this selection.



It is possible to control one receiver at a time. In this case, the AUX1 button must be in position A or B before START.

- To start operating, turn the **ON/OFF** switch to **START**, then release it.

When the AUX1 is set to selection A+B, the relay Aux1 is closed.

When the AUX1 is set to selection A or B, it is possible to activate the relay Aux1 by pressing one of the function buttons (F1 to F6) in the first speed, then confirm by turning the **ON/OFF** switch to **START** and releasing it.

In this case the relay Aux1 remains active for 30 seconds after the function button has been pressed.

If one of the other function buttons is pressed on second step, the relay Aux1 is instantaneously released.

7.6.2. Pairing One Transmitter to Two Receivers

For Tandem operation of one transmitter (Tx) with two receivers (RxA and RxB), follow the steps below:

- Switch on the Tx, RxA and RxB products.
- Perform the primary pairing of the Tx transmitter with the RxA receiver. Parameters of the RxA receiver are downloaded.
- Set up the RxA receiver.
- Perform the secondary pairing of the Tx transmitter with the RxA receiver.



In this configuration, the setting of the RxB secondary receiver cannot be carried out by the Tx transmitter. Parameters of the RxA receiver are downloaded.



The untimely loss of the radio link during operation in A + B selection will stop the steering.

7.6.3. Pairing Three Transmitters with Two Receivers

- Switch on the Tx and Rx products.
- Perform primary pairing of TxA with RxA. Parameters of the RxA receiver are downloaded.
- Perform primary pairing of TxB with RxB. Parameters of the RxB receiver are downloaded.
- Perform primary pairing of TxC with RxA.
- Perform secondary pairing of TxC with RxB.



The untimely loss of the radio link during operation in A + B selection will stop the steering.

7.6.4. Pairing Two Transmitters and Two Receivers

For operation in Tandem mode with two transmitters (TxA and TxB) with two receivers (RxA and RxB) in the same area, follow the steps below:

- Switch on the TxA, RxA products.
- Perform the main pairing of the TxA transmitter with the RxA receiver. Parameters of the RxA receiver are downloaded.
- Set up the RxA receiver. Parameters of the RxA receiver are downloaded.
- Switch on the TxB, RxB products.
- Perform the main pairing of the TxB transmitter with the RxB receiver. Parameters of the RxB receiver are downloaded.
- Perform the secondary pairing of the TxA transmitter with the RxB receiver.
- Perform the secondary pairing of the TxB transmitter with the RxA receiver.



The untimely loss of the radio link during operation in A + B selection will stop the steering.

7.6.5. Auto Release

After a safety shutdown or power failure, the receivers are automatically released. The receivers are again available and listening to the 2 transmitters.

7.6.6. Voluntary Release

Depending on the settings it is possible to manually release the receivers, to:

- release them for another use, or
- keep them, but make them unavailable to the neighboring transmitter.

A receiver can not be released only by the last transmitter used it.

A receiver can be released before the transmitter is turned off (Stop button or turning the **ON/OFF** switch to OFF):

- Hold the AUX1 button for 4 seconds: the transmitter sends release frames to the receiver. The receiver acknowledges the release by switching off the respective Aux1 relay.
- After 4 seconds, the A, B, C, and D LEDs turn off.



In some cases, release may not be feasible (interference, receiver too far away), in this case the receiver remains busy. Release is still possible by cutting the power supply to the receiver.



Caution, a receiver that has not been released can only be restarted by the last transmitter that used it.
For example, a primary receiver started by the primary transmitter but without release, cannot be released by the backup transmitter.

7.7. Stopping Products

7.7.1. Stopping in Standard Mode

To stop, turn the transmitter's **ON/OFF** switch to **0**.

Stopping is also possible by pressing the Stop button on the transmitter.

When the radio control turns off:

- All transmitter LEDs are off
- The receiver's safety relays are in an idle state

7.7.2. Stopping in Tandem Mode

Before switching off a transmitter (**ON/OFF** switch to **0**), release the paired receiver(s). See section 7.6.

Then stop the transmitter(s).

8. Product Settings

8.1. Access to Settings

All of the following settings must be configured after the primary pairing between the transmitter and the receiver. This operation must be done with the receiver powered on so that it can save the new settings.

8.1.1. Setting Entry

In Setting mode, the behavior of the battery and radio LEDs is as follows:

Transmitter Indicator Status	Description
The red battery LED and the green radio LED flash according to the Setting mode	A setting entry is active. The number of flashes of the battery LED/radio LED pair indicates the setting being modified as long as the ON/OFF switch is maintained in the START position. After releasing the switch, the battery and radio LEDs are off.

8.1.2. In Settings

The correspondence of the number of flashes of the radio LED according to the current setting is described below:

Status of transmitter's green radio LED	Description
Flashes 3 times periodically	Setting the AUX1 and AUX2 buttons
Flashes 4 times periodically	Setting the primary/secondary receiver data
Flashes 5 times periodically	Standby setting
Flashes 6 times periodically	Radio power setting
Flashes 7 times periodically	Protection sequence setting
Flashes 8 times periodically	Radio setting
Flashes 9 times periodically	"Tandem" mode release setting
Flashes 10 times periodically	Setting the sign-of-life mode "Duo" and "Tandem"
Flashes 11 times periodically	Horn setting
Flashes 12 times periodically	Passive stop setting
Flashes 13 times periodically	Info & Reset

8.2. Discarding a Setting

It is possible to stop a setting at any time by turning the **ON/OFF** switch to **0** or by pressing the Stop button.

8.3. Auxiliary Button Configuration (AUX1 + AUX2)

The transmitter's auxiliary pushbuttons can be configured in several ways according to needs: They can be associated with the Relay's function relays Aux 1, Aux 2-1, and Aux 2-2.

The **AUX1** and **AUX2** can be configured as follows:

- Pushbutton with momentary control (AUX1 and AUX2)
- Latching button (AUX1 and AUX2)
- Bridge selector button (Tandem AUX1)
- Relay selector button (AUX2).

LEDs A and B indicate the current setting of the AUX1 button and LEDs C and D indicate the setting of the AUX2 button. The settings and corresponding light signals are listed in the table below:

AUX1 button		LED A	LED B
Momentary control (Aux 1 relay)		continuous	OFF
Latching control (Aux 1 relay)		flashing	OFF
Tandem mode	A/B selection ⁽¹⁾	A and B flashing alternately	
	A/B/A + B selection ⁽¹⁾	ON sequence: A, B, A + B	
	Continuous selection A ⁽¹⁾	A alone, then B flashing stealthily	
	Continuous selection B ⁽¹⁾	B alone, then A flashing stealthily	
	Continuous A + B selection ⁽¹⁾	continuous	continuous
AUX2 button		LED C	LED D
Momentary control (Aux 2-1 relay)		continuous	OFF
Latching control (Aux 2-1 relay) ⁽²⁾		flashing	OFF
Selection C (Aux 2-1 relay)/D (Aux 2-2 relay)		C and D alternately	
Selection C (Aux 2-1 relay)/D (Aux 2-2 relay)/C + D		ON sequence: C, D, C + D	
Selection C (Aux 2-1 relay)/D (Aux 2-2 relay)/No relay		ON sequence: C, D, 0	

(1) Choice only possible on a transmitter associated with 2 receivers. The selection of receiver A and receiver B is then made by software (no relay) and based on the position of the Aux 1 switch and the A and/or B LED.

(2) When AUX momentary control:

- Aux 2-1 is active when the AUX2 button is pressed
- Aux 2-2 is active when the AUX2 button is released.

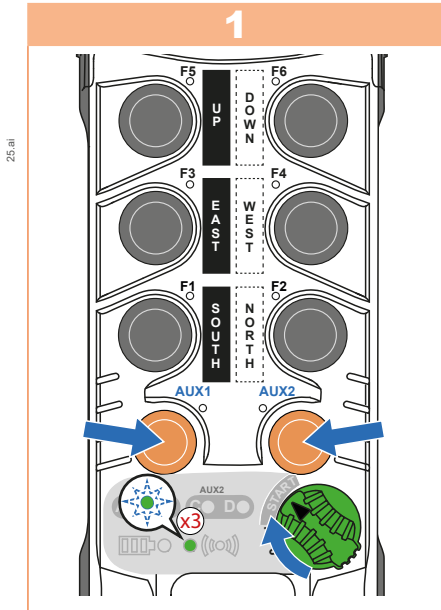

Turn **ON/OFF** switch to the **I** (ON) position. Ensure the LEDs A through D turn on and then off. Then press and hold the **AUX1** and **AUX2** buttons and turn the **ON/OFF** switch to **START**:

- The battery LED turns off
- The radio LED flashes 3 times.

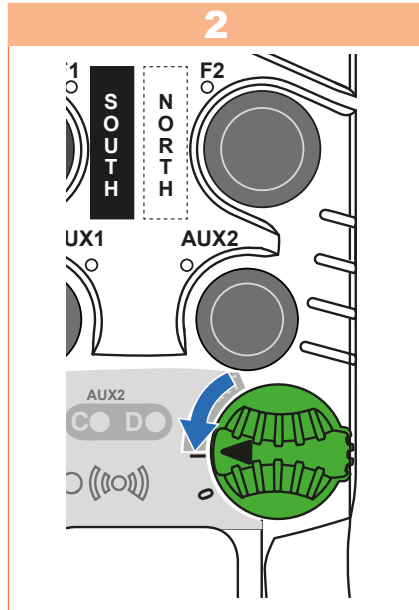

Release the **ON/OFF** switch and all other buttons to start the configuration.

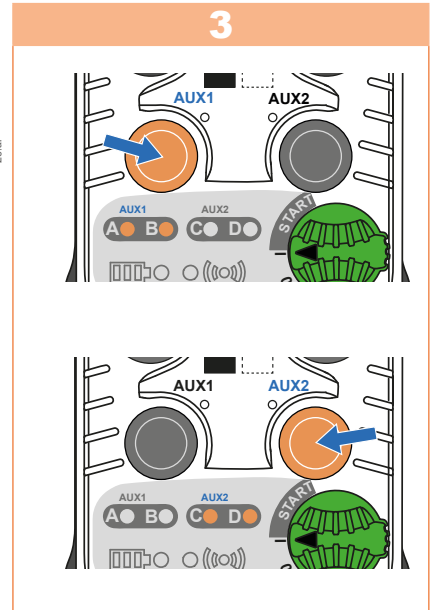

Each time one of the **AUX1** or **AUX2** buttons is pressed, the lighting sequence of the 2 corresponding LEDs indicates the operating mode.

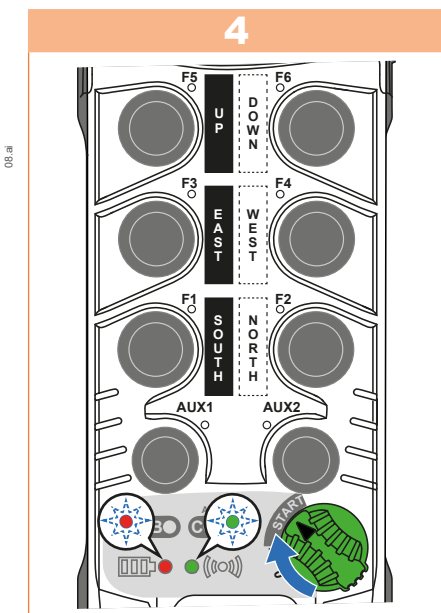

When the desired value is set, confirm it by turning the **ON/OFF** switch to **START**.
During transmission:

- Battery and radio LEDs flash alternately
- Receiver light turns on.

Note:

- If the auxiliary button is configured in receiver selection mode and the operator changes it to a standard or latching function button, this will automatically disable the current "Tandem" mode and erase the IDs (ID code and channel) of the second receiver.
- For maintained and latching control modes of operation of the auxiliary button AUX2, the Aux 2-2 relay is activated instead of relay Aux 2-1.

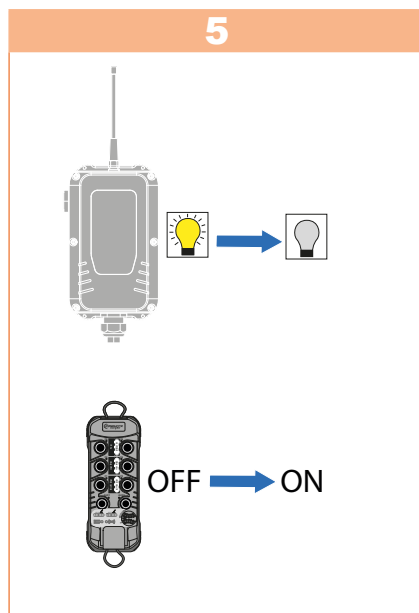

End of transmission:

- Receiver light turns off
- Transmitter shuts down and restarts.

8.4. Sleep Mode Configuration (F1 + F3)

The transmitter is put into standby mode if no function button has been pressed in the set time. The sleep time can be set from 1 to 99 minutes maximum and from 10 to 59 seconds.

The factory setting is 4 minutes. Products must be ready for configuration (perform steps in Chapter 7.1).

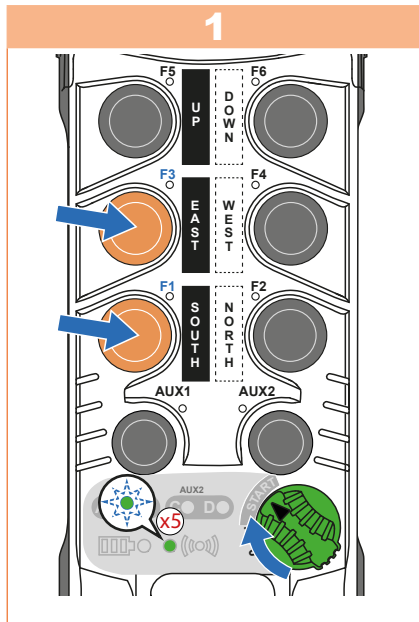

Turn **ON/OFF** switch to the **I** (ON) position. Ensure the LEDs A through D turn on and then off. Then press and hold the **F1** and **F3** buttons and turn the **ON/OFF** switch to **START**:

- The battery LED turns off
- The radio LED flashes 5 times.

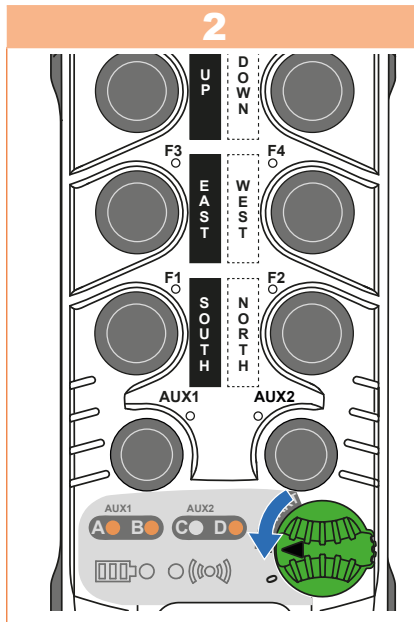

Release the **ON/OFF** switch and all other buttons:

- LED D indicates the unit of time (minutes = off, seconds = on)
- LED C indicates whether standby mode is active (off) or not (on)
- The value is given by LEDs A and B (A tens and B ones).

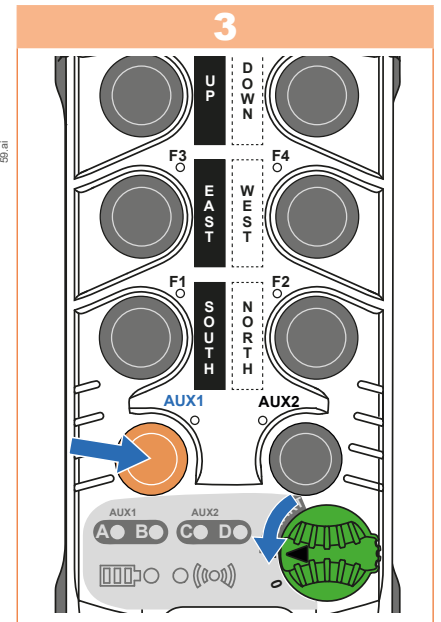

To disable sleep mode, press the **AUX1** button:

- LED C turns on
- LEDs A, B, and D are off.

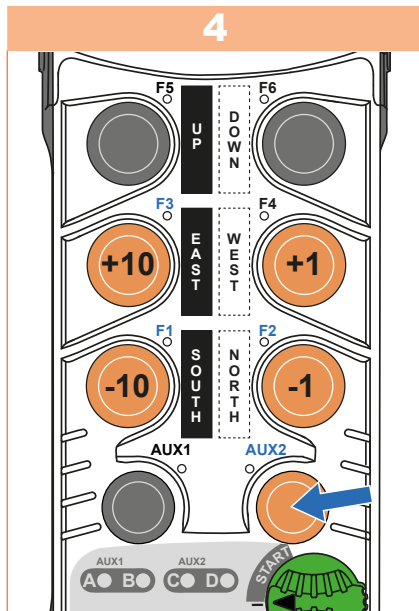

Set the desired value:

- Select the unit of time using the **AUX2** button (min or sec)
- Re-enter the value: decrement/increment the tenths with **F1/F3** and the units with **F2/F5**.

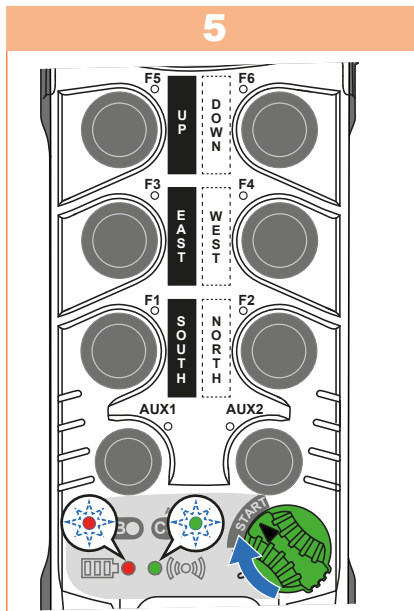

Confirm the value by turning the **ON/OFF** switch to **START**. During transmission:

- Battery and radio LEDs flash alternately
- Receiver light turns on.

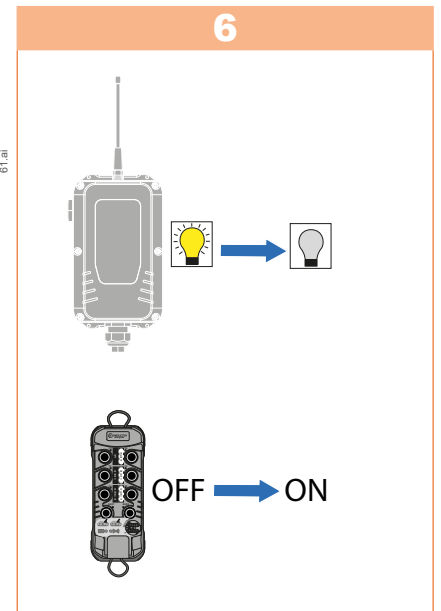

End of transmission:

- Receiver light turns off
- Transmitter shuts down and restarts.

8.5. Radio Power Configuration (F1 + F4)

By default, the transmitter and receiver modules analyze the quality of the signal received from both sides and adapt the power level according to the environment. However, it is possible to set the radio power of the products. Power is factory set to Auto. There are 2 power modes:

- **Auto** LED D is continuously on and A, B, and C are off
- **Fixed Manual**; LED D is off and LED B indicates the value of the power set in the range 1 (min) to 4 (max) by successive flashing.

Products must be ready for configuration (perform steps in Chapter 7.1).

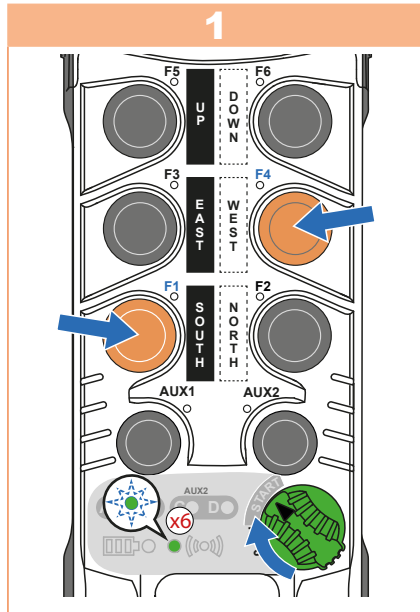

Turn **ON/OFF** switch to the **I** (ON) position. Ensure the LEDs A through D turn on and then off. Then press and hold the **F1** and **F4** buttons and turn the **ON/OFF** switch to **START**:

- The battery LED turns off
- The radio LED flashes **6** times.

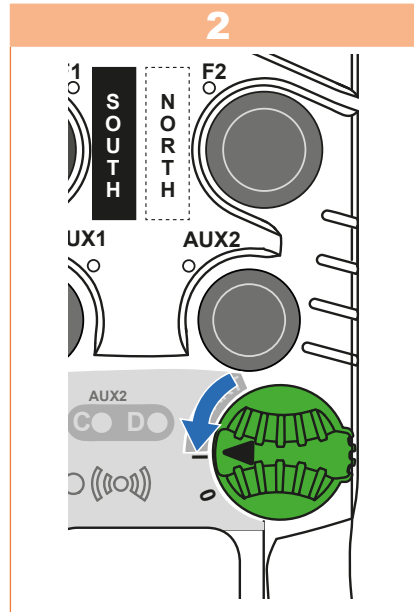

Release the **ON/OFF** switch and all other buttons to start the configuration.

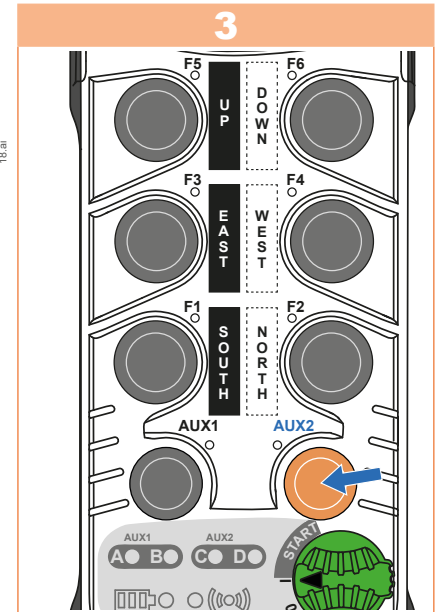

Press the **AUX2** button to enable automatic or manual mode.

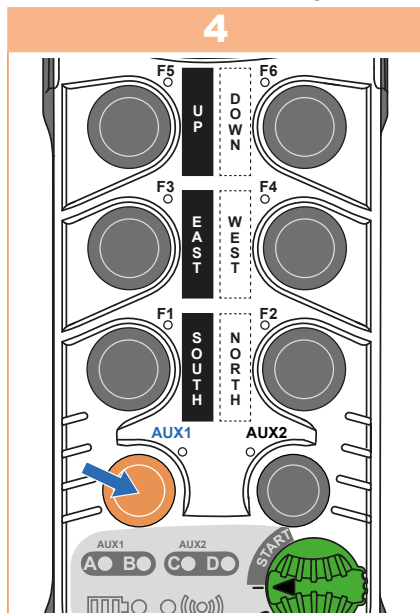

Press the **AUX1** button to scroll the power from 1 to 4.

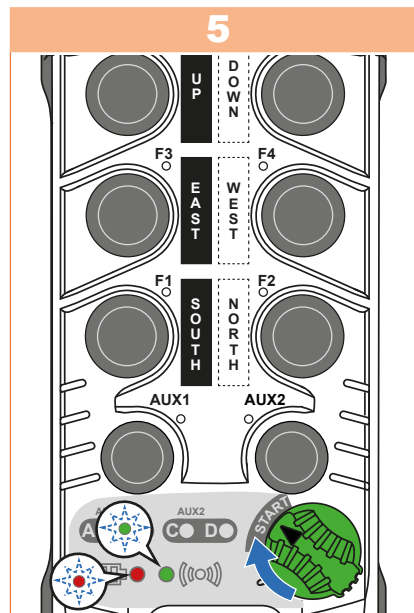

Confirm the value by turning the **ON/OFF** switch to **START**.

During transmission:

- Battery and radio LEDs flash alternately
- Receiver light turns on.

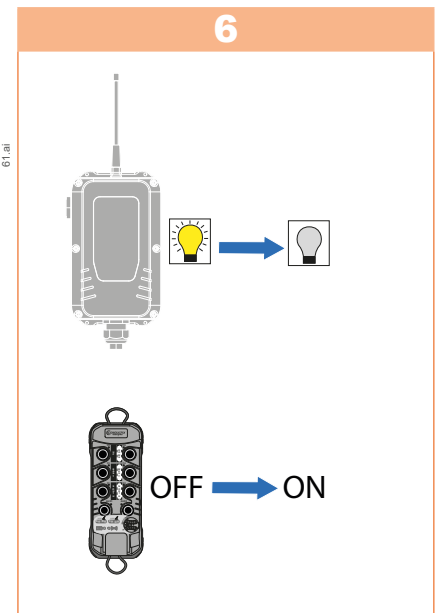

End of transmission:

- Receiver light turns off
- Transmitter shuts down and restarts.

8.6. Start protection and configuration (sequence with F1 – F6)

This setting protects the products with a code and prevents unauthorized use of the transmitter. The code represents a sequence obtained by a **combination of the six F1 to F6 buttons**.

The button sequence can be variable in length, from a minimum of 2 buttons to a maximum of 6 buttons.

It is possible to use the same button several times. Protection is not enabled in the factory setting.

Products must be ready for configuration (if the transmitter and receiver are not powered on and unlocked, perform the steps in Chapter 7.1).

Note:

- If a protection sequence is activated, it is not possible to do a secondary pairing. It is required to disable protection first with primary transmitter.

- If a protection sequence is configured in the receiver, to access the parameter configuration, this sequence is requested once at the first start of the transmitter after pairing.

Note:

To remove the pin code repeat process but do not enter a code at steps 4 and 7.

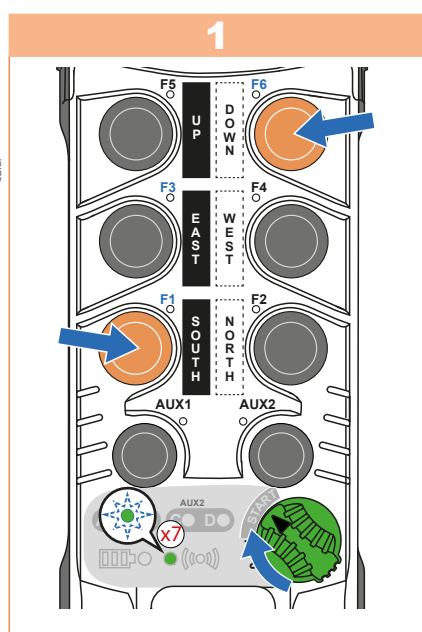

Turn **ON/OFF** switch to the I (ON) position. Ensure the LEDs A through D turn on and then off. Then press and hold the **F1 and F6** buttons and turn the **ON/OFF** switch to **START**:

- The battery LED turns off
- The radio LED flashes 7 times.

Two protection types are available: at product start-up or only on settings and pairing functions.

Each time the **AUX2** button is pressed, the **LED C** lights up and turns off to activate or deactivate the protection sequence on start-up or only on settings and pairing.

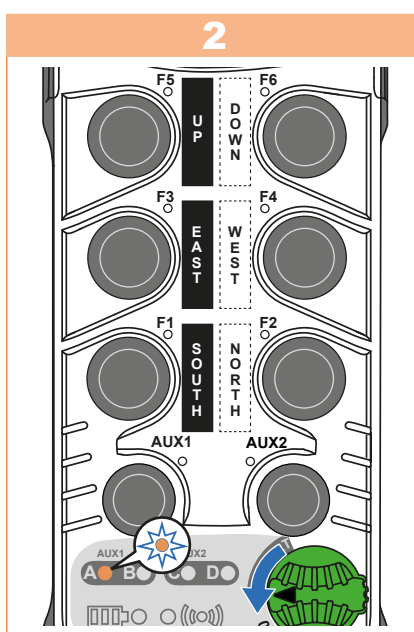

Release the **ON/OFF** switch and all other buttons to start the configuration.

The continuously on LED A indicates that the transmitter is waiting for the new sequence.

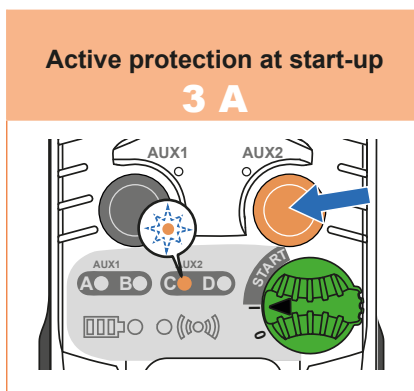

When **LED C** lights on: the protection is active at start-up.

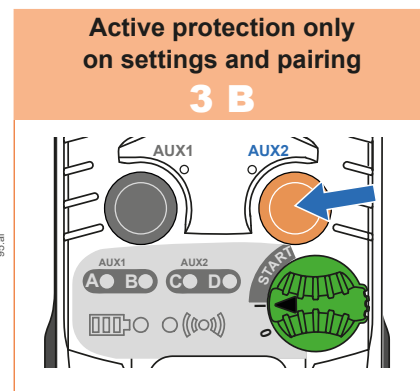

When **LED C** is off: the protection is active only on the settings and pairing functions.

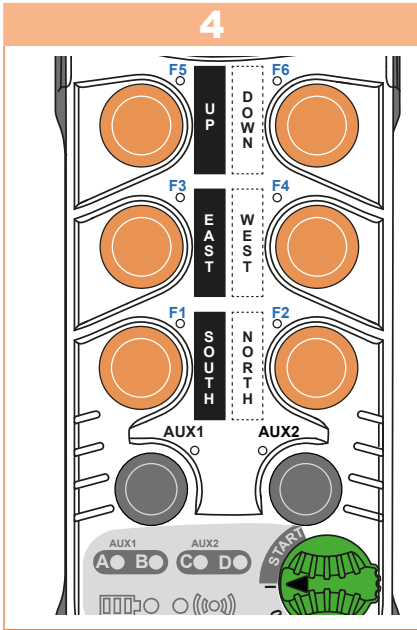

Enter the code by pressing successively on the buttons (chosen sequence): LED A turns off then on after each pressing of the F1 to F6 button. Do not press any button to clear the previous code and disable it at power up.

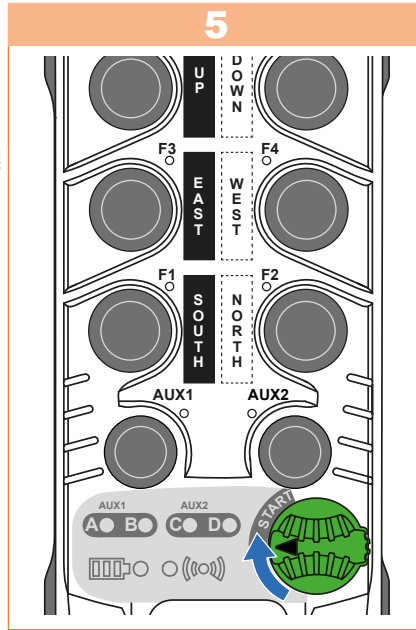

At the end of the sequence, confirm by turning the ON/OFF switch to **START**. **Note:** If the sequence entered is incorrect (length), you are returned to Step 2.

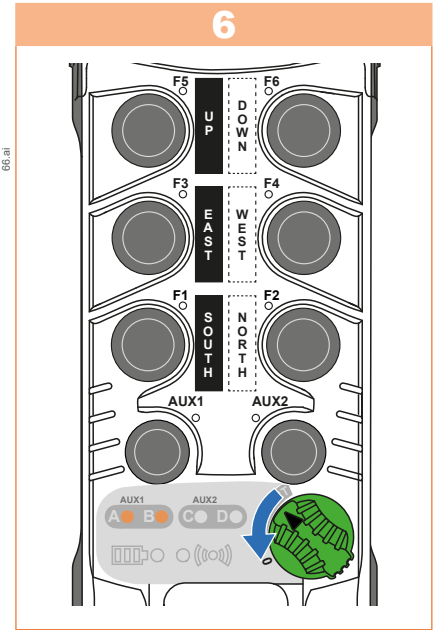

Release the **ON/OFF** switch: LEDs A and B are continuously on to indicate that the code must be re-entered to confirm it.

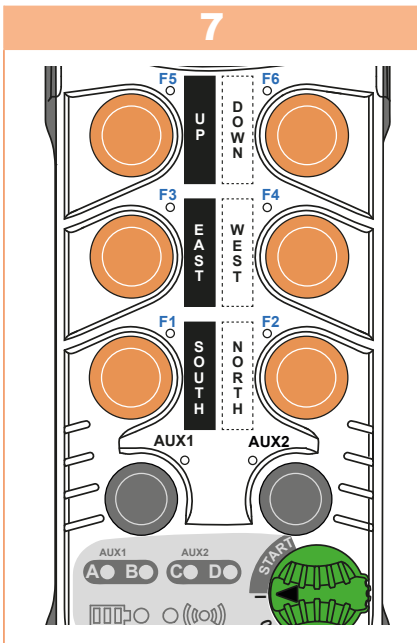

Re-enter the sequence: LEDs A and B go out after each pressing of the **F1 to F6** function buttons. Do not press any button to clear the previous code and disable it at power up.

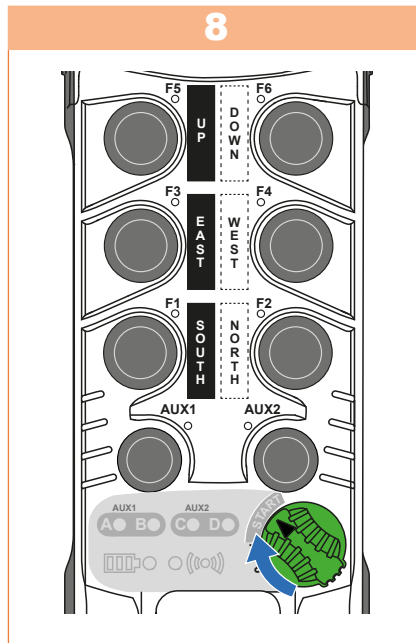

Confirm by turning the **ON/OFF** switch to **START**.

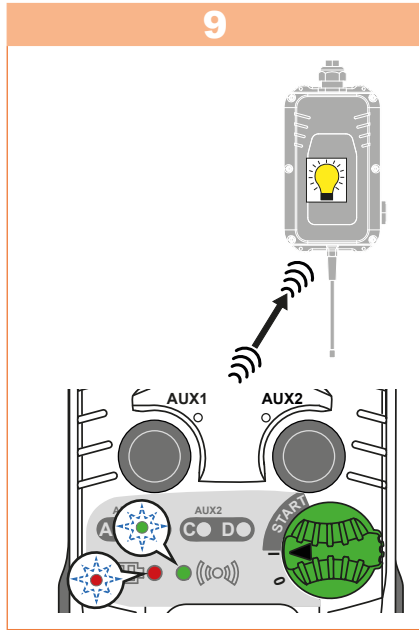

If the two codes entered are the same, the sequence is transmitted to the receiver.
 During transmission:

- Battery and radio LEDs flash alternately
- Receiver light turns on.



When the sequence is incorrect, the red LED lights up for 2 sec and LEDs A, B, C and D flash.

If the second code is different from the first code, resume Step 2.

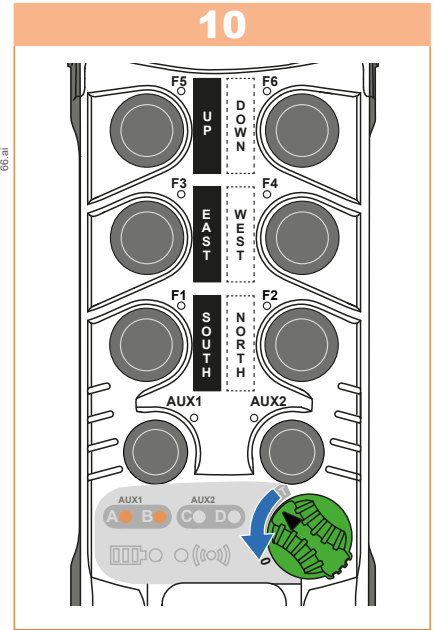

End of transmission:

- Receiver light turns off
- Transmitter shuts down and restarts.

8.7. RF Channel Configuration (F1 + F2)

8.7.1. Fixed Radio Channel Setting

The radio channel of the transmitter and receiver can be set from **1-92** and the number of flashes of LEDs A and B indicate the radio channel number.

Products must be ready for configuration (if the transmitter and receiver are not powered on and unlocked, perform the steps in Chapter **7.1**).

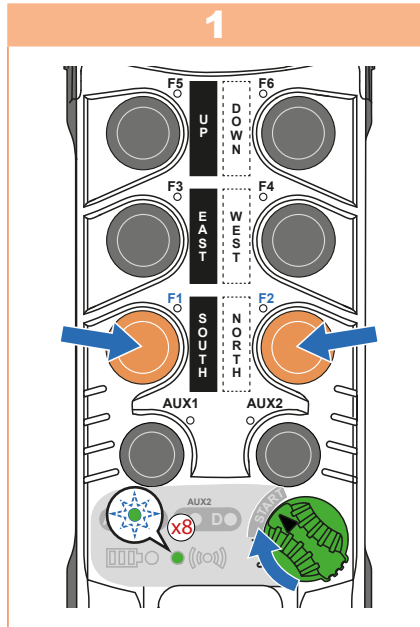

Turn **ON/OFF** switch to the **I** (ON) position. Ensure the LEDs A through D turn on and then off. Then press and hold the **F1** and **F2** buttons and turn the **ON/OFF** switch to **START**:

- The battery LED turns off
- The radio LED flashes **8** times.
- LEDs C and D are off.

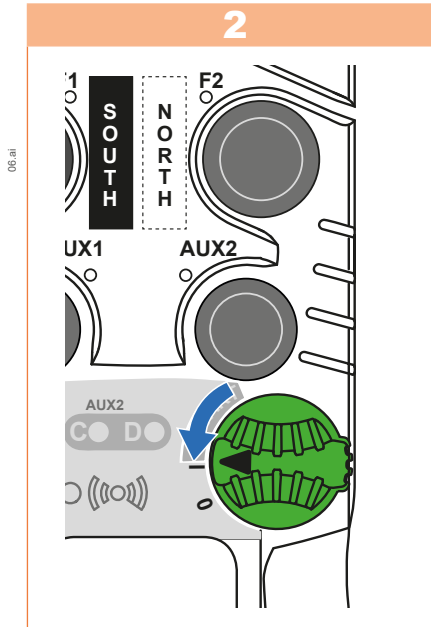

Release the **ON/OFF** switch and all other buttons to start the configuration.

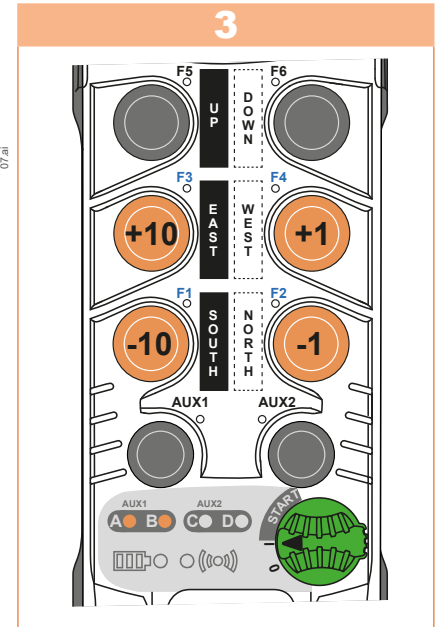

Set the channel:

- Decrement/increment the tens with F1/F3
- Decrement/increment the ones with F2/F4.

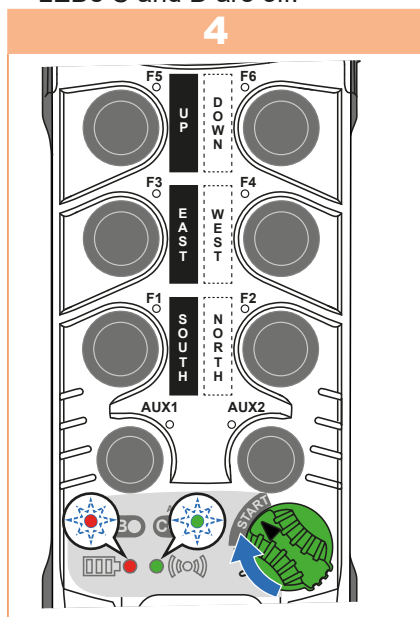

Confirm the channel by turning the **ON/OFF** switch to **START**. During transmission:

- Battery and radio LEDs flash alternately
- Receiver light turns on.

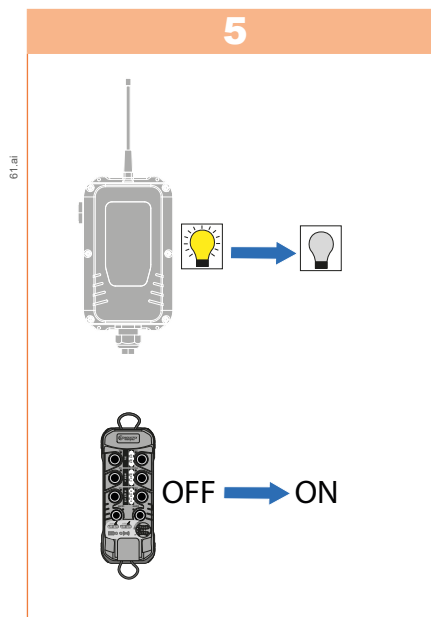

End of transmission:

- Receiver light turns off
- Transmitter shuts down and restarts.

8.7.2. Channel Auto Selection Setting (Aux2)

The **channel auto selection** function scans the frequency band used in the area where products are installed and identifies channels not used in this area by other equipment. For best results, it is necessary to leave the search function on for a few minutes, when there is the most radio activity in the area near the receiver. Products must be ready for configuration (if the transmitter and receiver are not powered on and unlocked, perform the steps in Chapter 7.1).

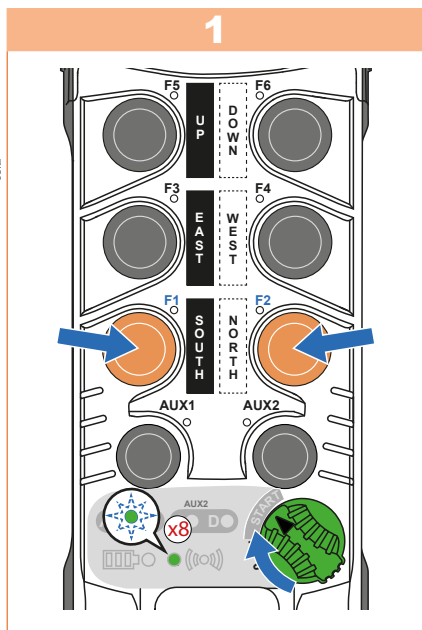

Turn **ON/OFF** switch to the I (ON) position. Ensure the LEDs A through D turn on and then off. Then press and hold the **F1** and **F2** buttons and turn the **ON/OFF** switch to **START**:

- The battery LED turns off
- The radio LED flashes **8** times.

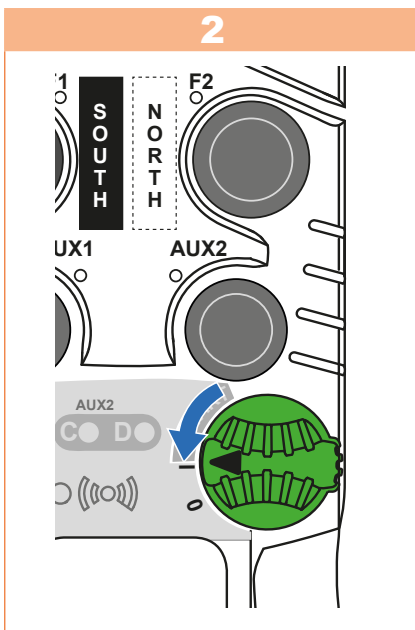

LED A indicates the tenths and LED B the units of the current channel. LEDs C and D are off. Release the **ON/OFF** switch and all other buttons to start the configuration.

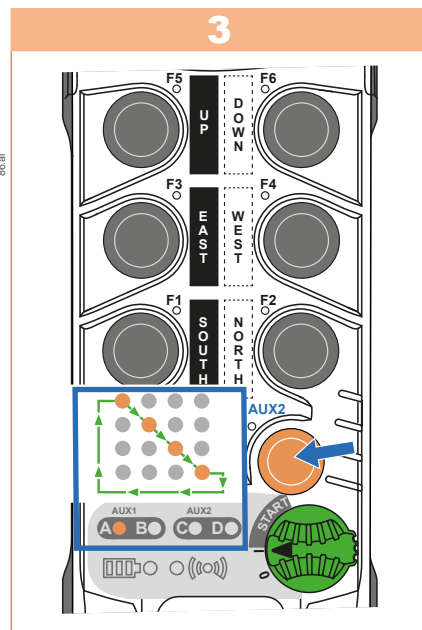

Press the **AUX2** button to start the procedure. During the scan, LEDs A, B, C, and D flash one after the other. If this LEDs sequence stops and goes to next step (4), this is due to loss communication with the receiver.

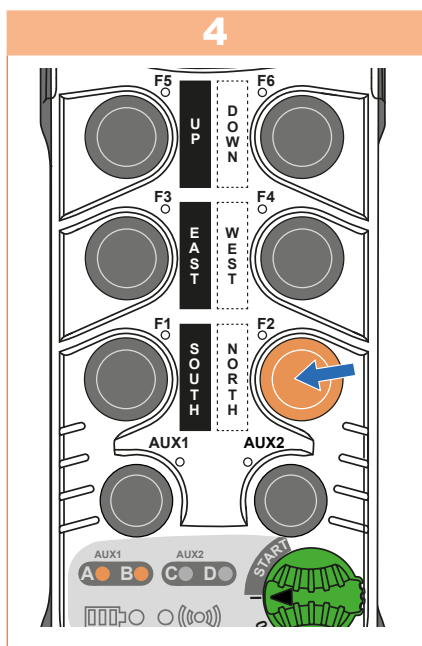

Press **F2** button on the transmitter to stop the scan. LED A indicates the tenths and B the units of the best radio channel found.

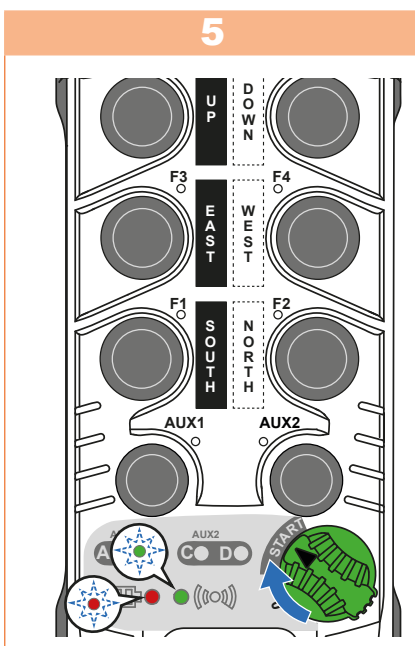

Confirm the channel by turning the **ON/OFF** switch to **START**. During transmission:

- Battery and radio LEDs flash alternately
- Receiver light turns on.

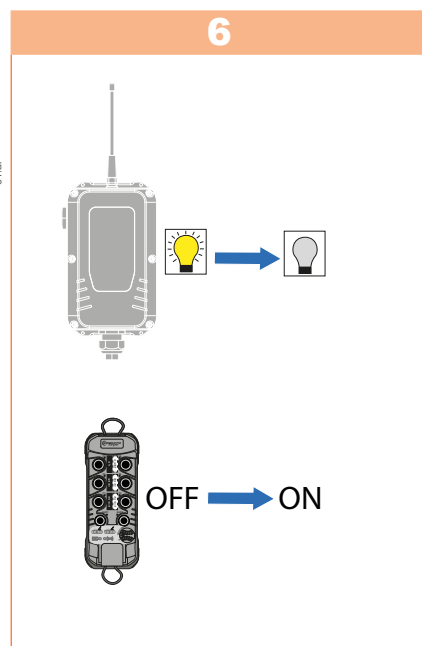

End of transmission:

- Receiver light turns off
- Transmitter shuts down and restarts.

8.7.3. Free Channel Startup Setting (F5)

When the receiver is not communicating with the associated transmitter, it alternately listens to its current channel and the other channels of the frequency band. It then determines the channel that seems to be the best. Free channel startup informs the transmitter at start-up to use the best available channel selected by the receiver.

Products must be ready for configuration (if the transmitter and receiver are not powered on and unlocked, perform the steps in Chapter 7.1).

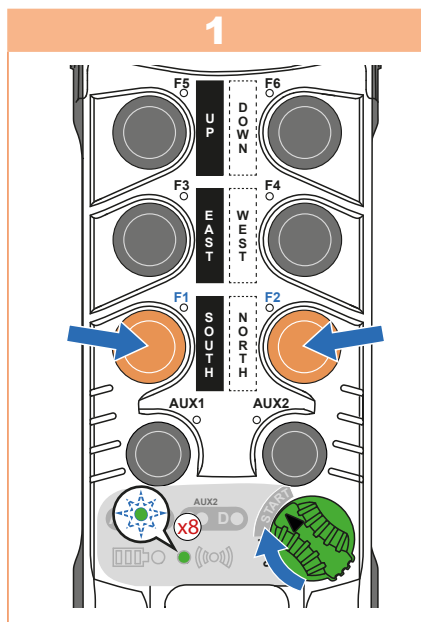

Turn **ON/OFF** switch to the **I** (ON) position. Ensure the LEDs A through D turn on and then off. Then press and hold the **F1** and **F2** buttons and turn the **ON/OFF** switch to **START**:

- The battery LED turns off
- The radio LED flashes **8** times.

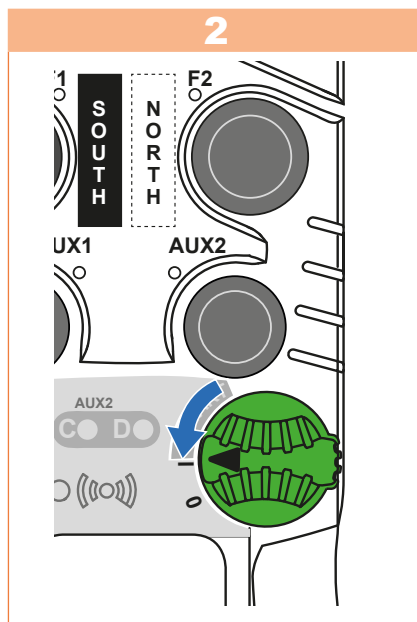

Release the **ON/OFF** switch and all other buttons to start the configuration.

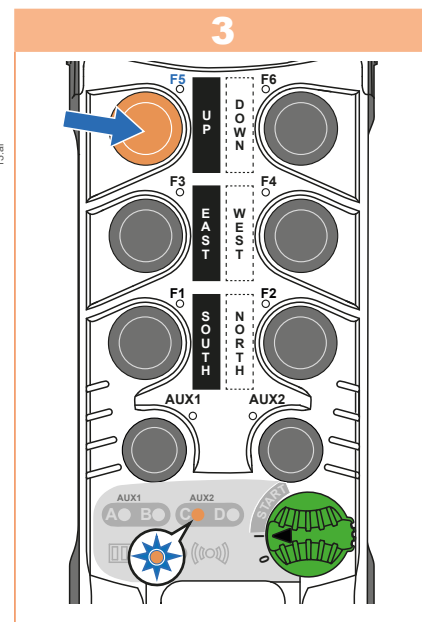

Press the **F5** button to enable the mode:

- Only LED C is continuously on
- LEDs A, B, and D are off.

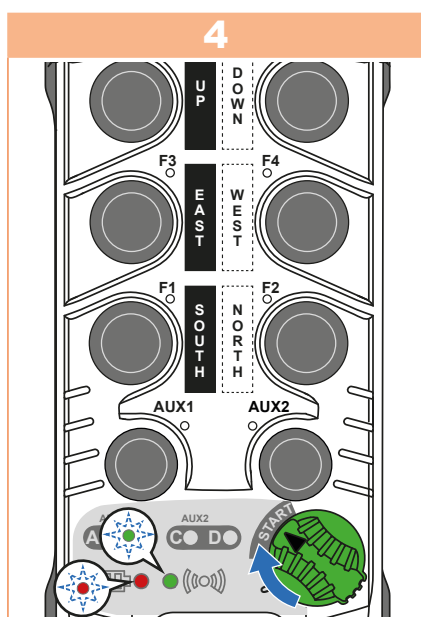

Confirm the value by turning the **ON/OFF** switch to **START**. During transmission:

- Battery and radio LEDs flash alternately
- Receiver light turns on.

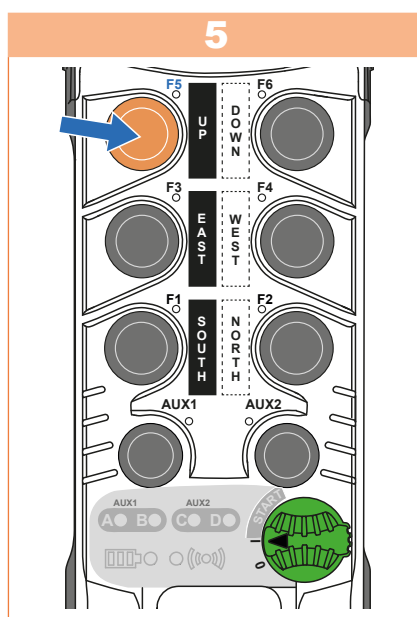

To disable the mode, press the **F5** button. This returns to the fixed radio channel setting (refer to Chapter 8.7.1).

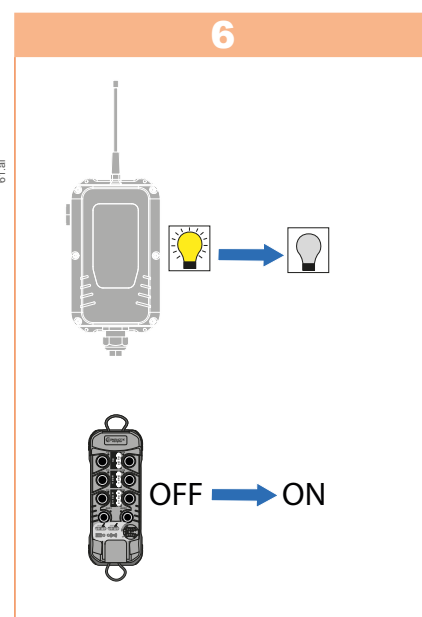

End of transmission:

- Receiver light turns off
- Transmitter shuts down and restarts.

8.7.4. Channel Agility Setting (F6)

The channel agility setting changes the channel automatically when it has been identified as busy, following a priority algorithm. Changing the radio channel is initiated by the receiver which transmits this information to the transmitter.

Products must be ready for configuration (if the transmitter and receiver are not powered on and unlocked, perform the steps in Chapter 7.1).

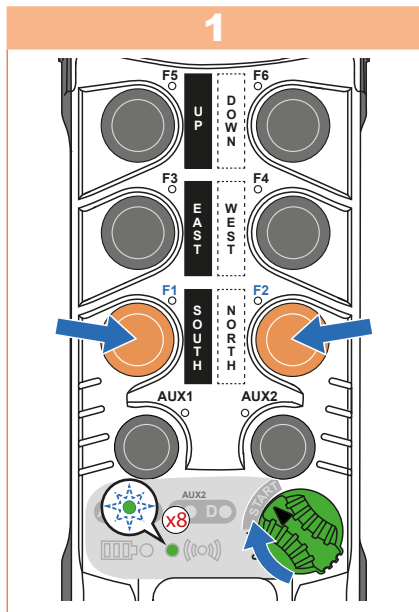

Turn **ON/OFF** switch to the **I** (ON) position. Ensure the LEDs A through D turn on and then off. Then press and hold the **F1** and **F2** buttons and turn the **ON/OFF** switch to **START**:

- The battery LED turns off
- The radio LED flashes 8 times.

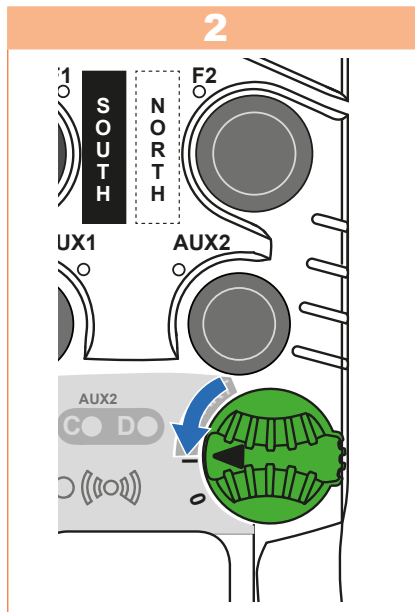

Release the **ON/OFF** switch and all other buttons to start the configuration.

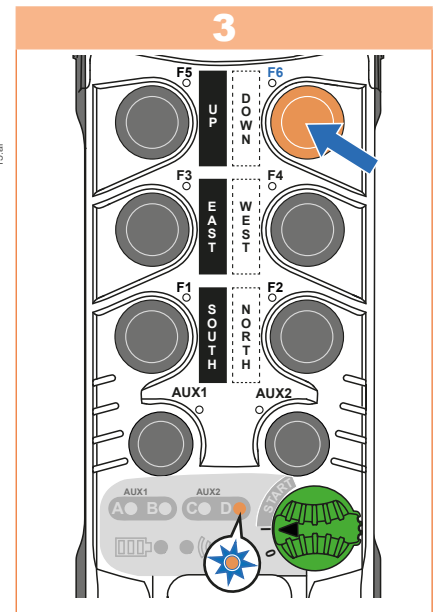

Press the **F6** button to enable the mode: LED D must be on and LED C must be off.

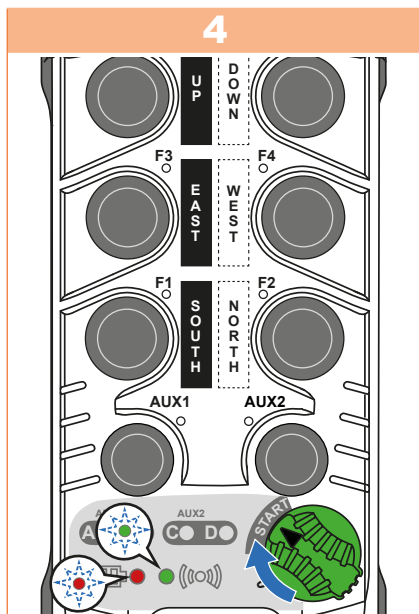

Confirm the value by turning the **ON/OFF** switch to **START**. During transmission:

- Battery and radio LEDs flash alternately
- Receiver light turns on.

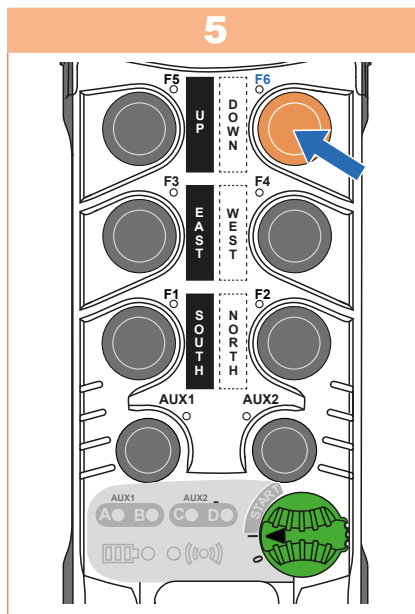

To disable the mode, press the **F6** button. This returns to the fixed radio channel setting (refer to Chapter 8.7.1).

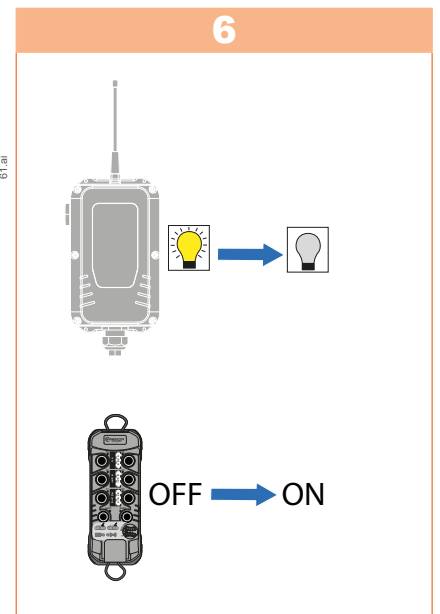

End of transmission:

- Receiver light turns off
- Transmitter shuts down and restarts.

8.8. Receiver Horn Configuration (AUX2 + F1)

This setting allows you to define different modes of operation of the horn signal according to needs and LEDs A,B,C, and D indicate the pattern and the sound level:

- **Pattern Selection:** Configurable from 1 to 99 ↔ LED A indicates tens and LED B indicates the ones.
- **Automatic Pattern:** This depends on the radio channel used ↔ indicated by LED D (automatic when the LED is on and manual when the LED is off).
- **Sound Level:** Configurable from 1 to 2 ↔ indicated by LED C (high if the LED is on and low if the LED is off).

By default, products are delivered in automatic pattern mode and level 2.

The buzzer is active according to a pattern depending on the setting or radio channel (automatic) of the receiver. Products must be ready for configuration (perform steps in Chapter 7.1).

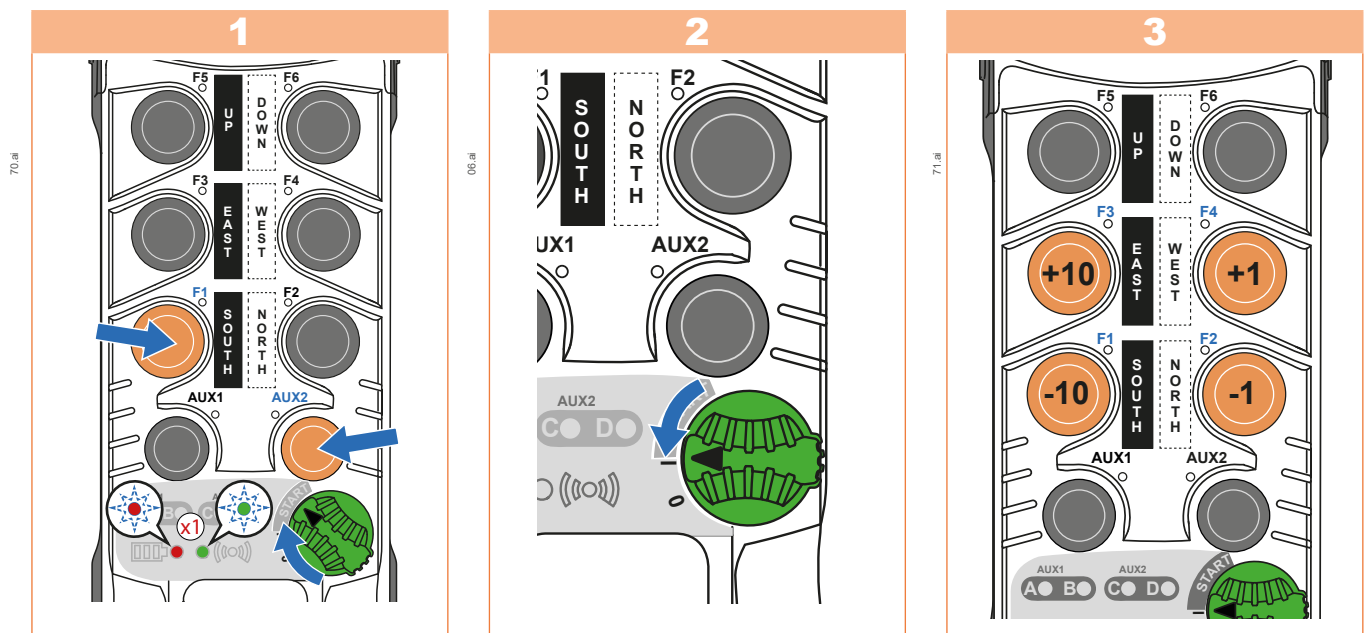

Turn **ON/OFF** switch to the **I** (ON) position. Ensure the LEDs A through D turn on and then off. Then press and hold the **AUX2** and **F1** buttons and turn the **ON/OFF** switch to **START**: Battery and radio LEDs flash once in a loop.

Release the **ON/OFF** button and all other buttons to start configuration. LEDs indicate the existing configuration.

To change the pattern:

- Decrement/increment the tens with F1/F3
- Decrement/increment the ones with F2/F4.

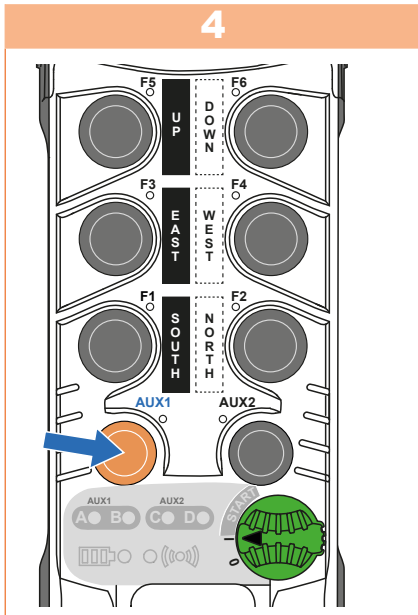

Select the desired sound level using the **AUX1** button.

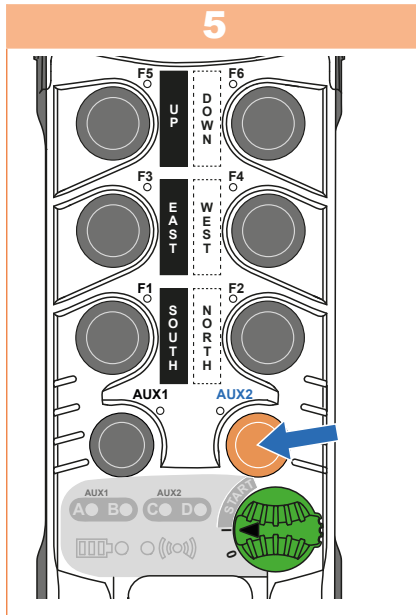

The **AUX2** button enables automatic mode.

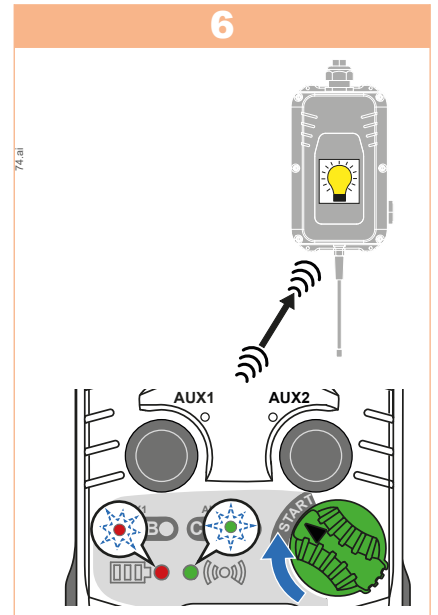

Confirm the value by turning the **ON/OFF** switch to **START**.
 During transmission:

- Battery and radio LEDs flash alternately
- Receiver light turns on.

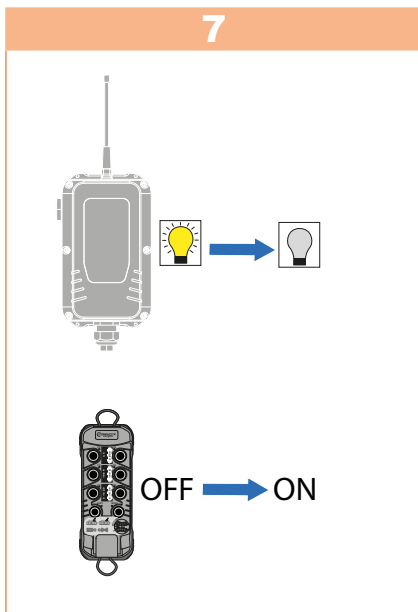

End of transmission:

- Receiver light turns off
- Transmitter shuts down and restarts.

8.9. Passive stop Configuration (AUX1 + AUX2 + F1 + F2)

In case of radio interference or a too far distance between the equipment and the transmitter, the radio communication may be interrupted. In this case, a command to stop the equipment movement (by releasing the transmitter button) may not be taken into account.

To avoid risks, the movement is stopped with a "passive stop" delay. The remote control has four passive stop delays and the setting value is indicated by LED B: 0.3 sec (1 flash), 0.5 sec (2 flashes), 1 sec (3 flashes) and 1.5 sec (4 flashes).

The passive time must be properly chosen according to the risk analysis of the equipment to be controlled:

- If too short, unwanted stops may occur frequently
- If too long, the movement may continue for too long and can create dangerous situations.

Products must be ready for configuration (if the transmitter and receiver are not powered on and unlocked, perform the steps in Chapter 7.1).

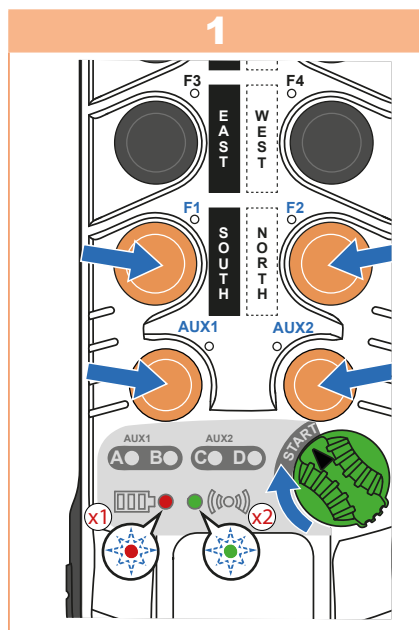

Turn **ON/OFF** switch to the **I** (ON) position. Ensure the LEDs A through D turn on and then off. Then press and hold at the same time **AUX1**, **AUX2**, **F1** and **F2** buttons and turn the **ON/OFF** switch to **START**:

- The battery LED flashes **ones**
- The radio LED flashes **2** times.

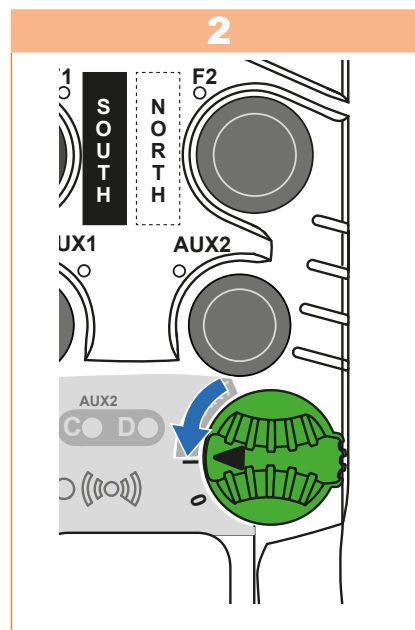

Release the **ON/OFF** switch and all other buttons to start configuration.

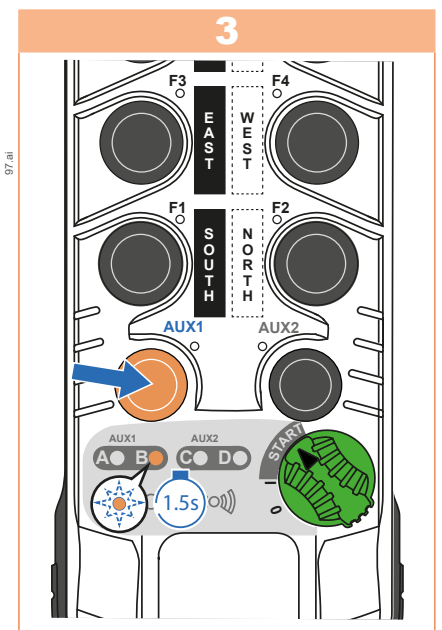

The passive stop delay is factory-set to 0.5 sec and the LED B flashes 1 time. Press the **AUX1** to scroll through the four passive stop delays: the number of flashes on the LED B indicates the selected value.

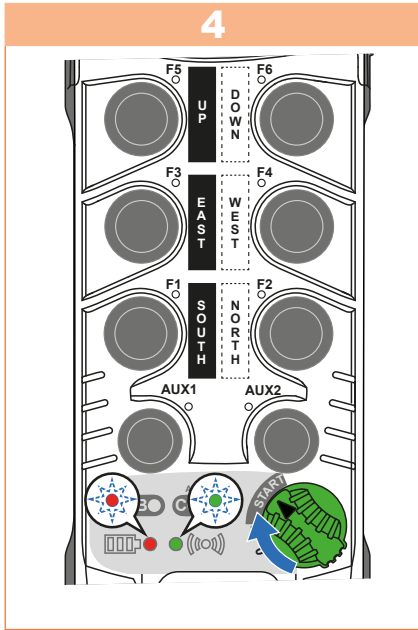

Confirm the value by turning the **ON/OFF** switch to **START**.
 During transmission:

- Battery and radio LEDs flash alternately
- Receiver light turns on.

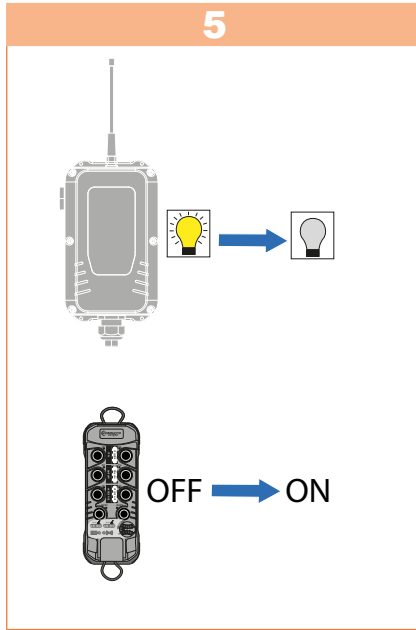

End of transmission:

- Receiver light turns off
- Transmitter shuts down and restarts.



It is possible to abort by turning the **ON/OFF** switch from **I** to **0**.

8.10. Info & Reset Menu (AUX1 + F4)

This menu allows you to restore the factory defaults and check the transmitter and receiver software versions. The reset has the following action:

- To delete possible secondary receivers controlled by the transmitter (Tandem)
- To delete all transmitters paired to the receiver except the main receiver used
- To restore all factory defaults (refer to Chapter 6.3).

After a reset, the factory defaults are restored and only the transmitter used for the reset is able to communicate with the "reseted" receiver and consequently to drive the equipment.

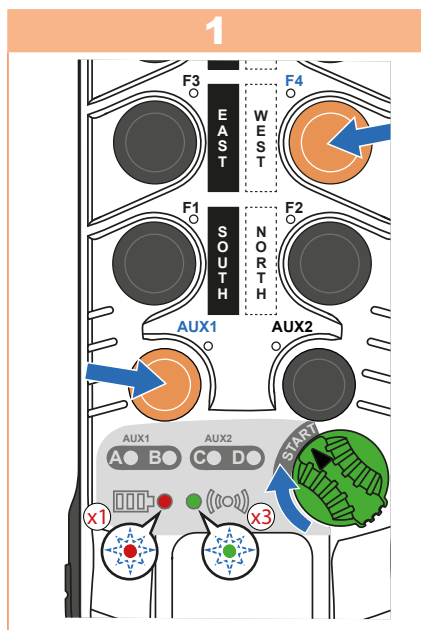

Turn **ON/OFF** switch to the **I** (ON) position. Ensure the LEDs A through D turn on and then off. Then press and hold the **AUX1** and **F4** buttons and turn the **ON/OFF** switch to **START**:

- The battery LED flashes once
- The radio LED flashes 3 times.

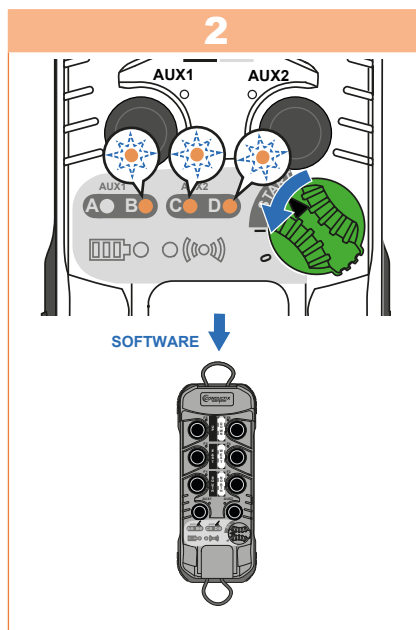

Release the **ON/OFF** switch and all other buttons, the transmitter software version is displayed (green radio LED is off):

- LED B indicates the hundreds
- LED C indicates the tens
- LED D indicates the units.

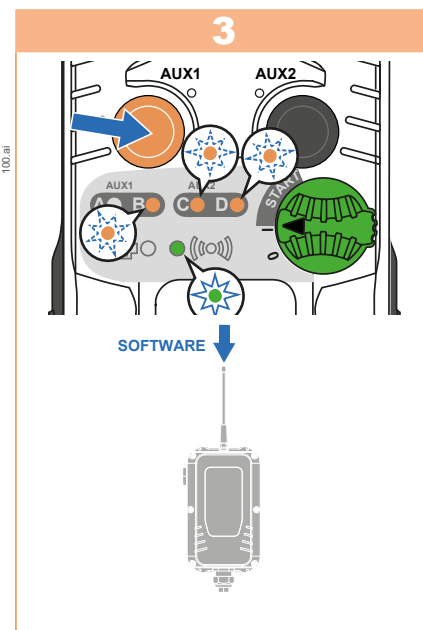

To display receiver software version press the **AUX1** button: the green radio LED turns on and the B, C and D LEDs indicate the version number (in order hundreds, tens and units).

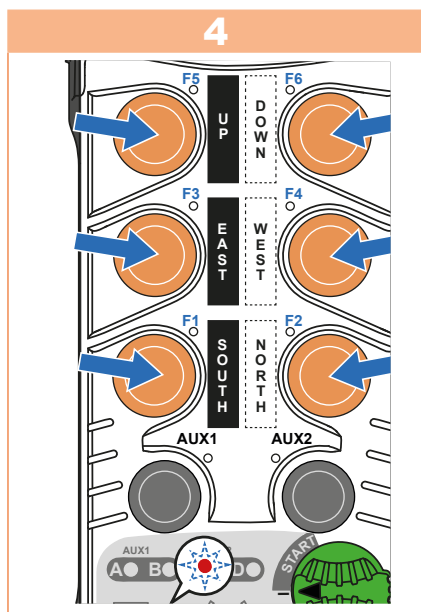

To pre-select a reset press successively the **F1**, **F2**, **F3**, **F4**, **F5** and **F6** buttons: the battery LED is blinking and all other LEDs are off.

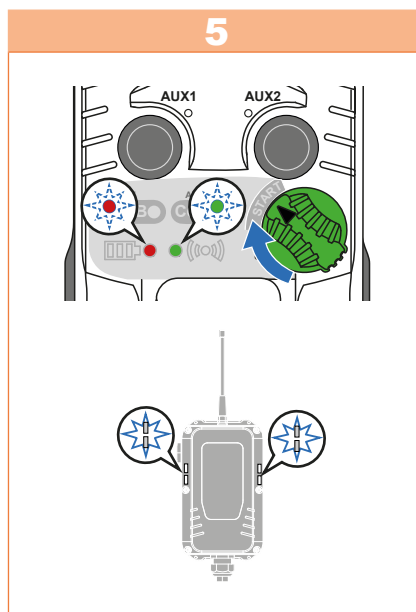

Validate the reset by turning the **ON/OFF** switch to **START**: battery and radio LEDs flash alternately and the receiver memorize the factory defaults (white lamp is on).



To abort the reset, turn the **ON/OFF** switch from I to 0.

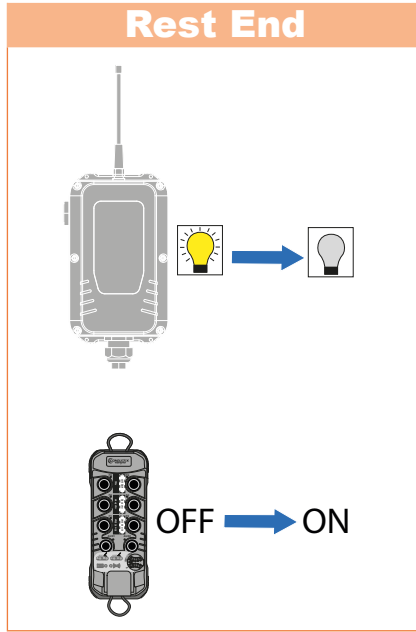

At the reset end:

- Receiver white lamp turns off
- Transmitter shuts down and restarts.

9. Specific Tandem Mode Settings

9.1. Receiver Swapping A ↔ B (AUX1 + F5)

This feature swaps the selection indicator of the AUX1 button.

This feature is used when paired in a tandem because each transmitter automatically puts the primary paired receiver as A and the secondary paired receiver as B. Use this to switch naming on any transmitters that do not match site naming for crane A and B.

Swapping configuration is indicated by LEDs A and B:

- The selection indicators of receivers A and B are not swapped if LED A is on and LED B is off
- The selection indicators of receivers A and B are not swapped if LED A is off and LED B is on.

Products must be ready for configuration (perform steps in Chapter 7.1).

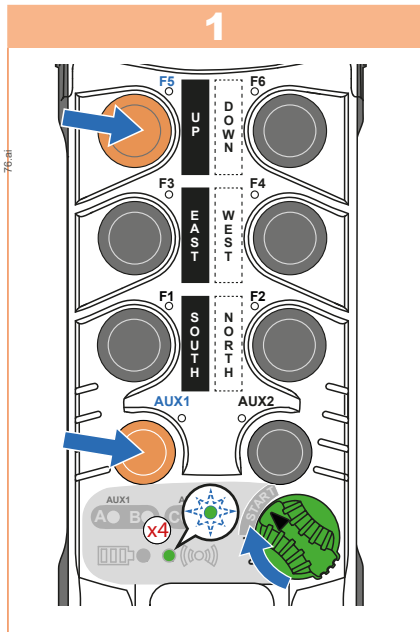

Turn **ON/OFF** switch to the **I** (ON) position. Ensure the LEDs A through D turn on and then off. Then press and hold the **AUX1** and **F5** buttons and turn the **ON/OFF** switch to **START**:

- The battery LED turns off
- The radio LED flashes 4 times.

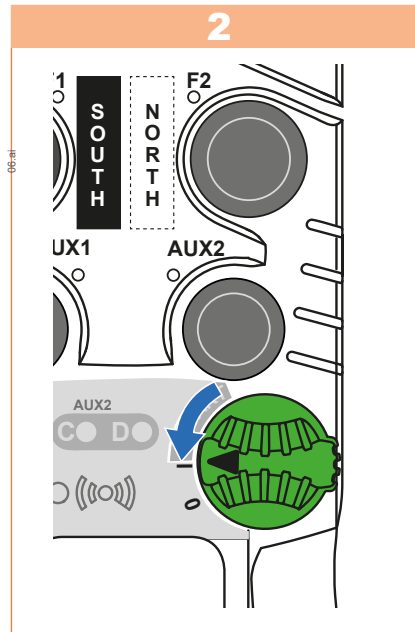

Release the **ON/OFF** switch and all other buttons: LEDs A and B indicate whether swapping is enabled or disabled.

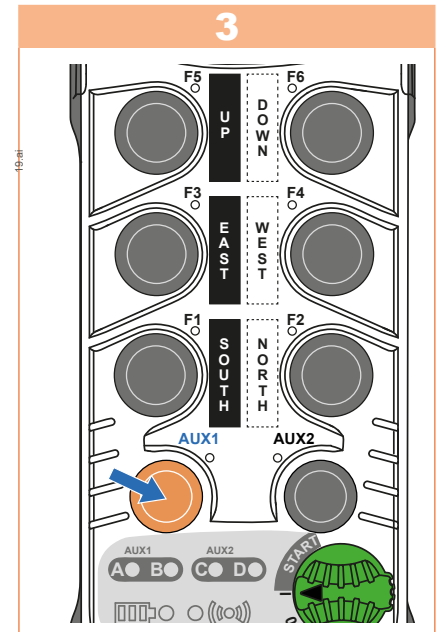

To switch from one mode to another press the **AUX1** button.

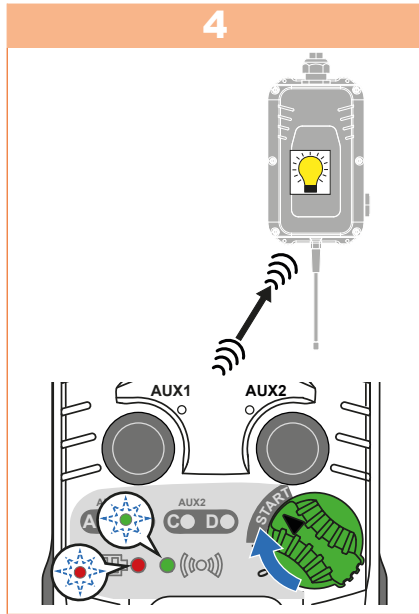

Confirm the value by turning the **ON/OFF** to **START**.
During transmission:

- Battery and radio LEDs flash alternately
- Receiver light turns on.

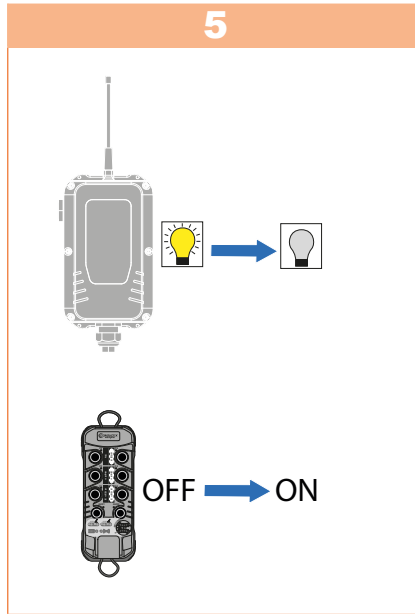

End of transmission:

- Receiver light turns off
- Transmitter shuts down and restarts.



By default, after configuring an AUX1 function button and after pairing, swapping is disabled.

9.2. Release Function (Ungroup) (AUX1 + F3)

This setting allows you to configure the release of one or more receivers that work with the transmitter. If automatic release mode is enabled, when the transmitter stops operating, the paired receiver(s) will be released and another transmitter can connect later.

In the voluntary release mode, the operator must voluntarily release or not the receivers.

Products are configured by default in automatic release mode.

Release mode is indicated by the pair of A and B LEDs:

- For automatic release, LED A is on and LED B is off
- For voluntary manual release, LED A is off and LED B is on.

Products must be ready for configuration (perform steps in Chapter 7.1).

Note: When you change this parameter, it is recommended to do the same change on both receivers. So this procedure needs to be done with the primary Tx of each Rx.

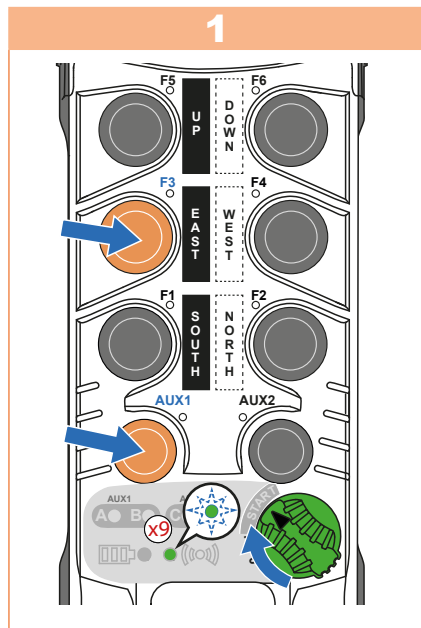

Turn **ON/OFF** switch to the **I** (ON) position. Ensure the LEDs A through D turn on and then off. Then press and hold the **AUX1** and **F3** buttons and turn the **ON/OFF** switch to **START**:

- The battery LED turns off
- The radio LED flashes 9 times.

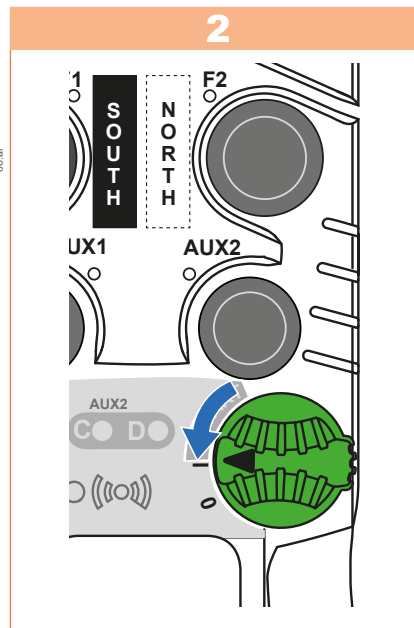

Release the **ON/OFF** switch and all other buttons: LEDs A and B indicate the active release mode (auto or voluntary).

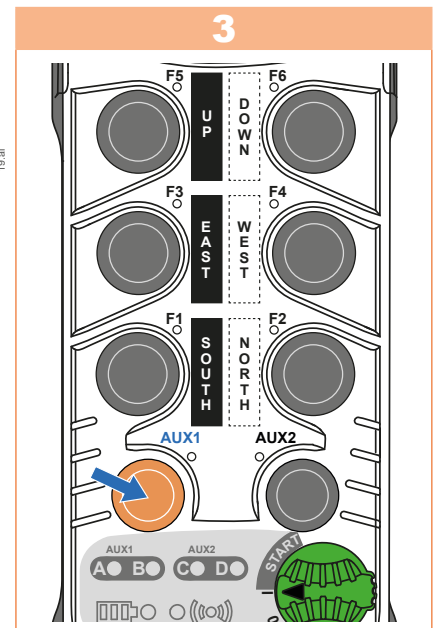

To switch from one mode to another press the **AUX1** button.

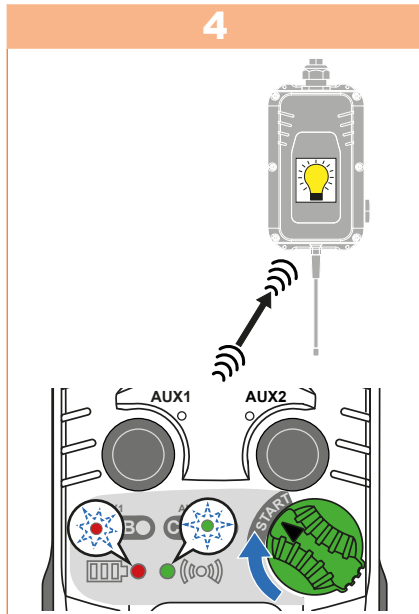

Confirm the value by turning the **ON/OFF** switch to **START**.
 During transmission:

- Battery and radio LEDs flash alternately
- Receiver light turns on.

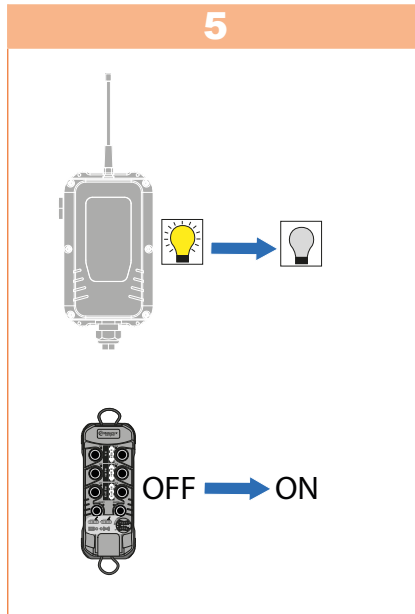

End of transmission:

- Receiver light turns off
- Transmitter shuts down and restarts.

9.3. Sign of Life Between Receivers (F1 + F5)

In Tandem mode a sign of life is exchanged between the two receivers. This function is only valid when the transmitter controls both receivers (A + B).

The sign of life determines if one of the receivers has released its safety relays or if radio communication between the two is broken.

Products are configured at the factory in active life sign mode.

Configuration of the sign of life mode is indicated by the pair of A and B LEDs:

- Sign of life is enabled if LED A is on and LED B is off
- Sign of life is disabled if LED A is off and LED B is on.



If the sign of life disappears and one of the receivers has gone to safety, the second receiver will go to safety (this condition is only true, if the communication between receivers is available).

If the sign of life disappears but the two receivers are still in operation (safety relay active), only the function output relay commands are disabled.

Products must be ready for configuration (if the transmitter and receiver are not powered on and unlocked, perform the steps in Chapter 7.1).

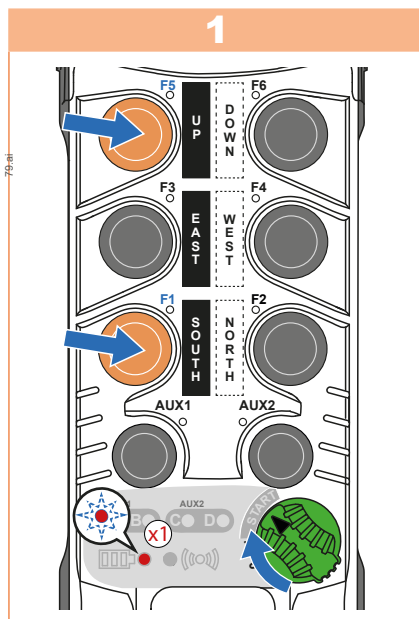

Turn **ON/OFF** switch to the **I** (ON) position. Ensure the LEDs A through D turn on and then off. Then press and hold the **F1** and **F6** buttons and turn the **ON/OFF** switch to **START**:

- The battery LED flashes once
- The radio LED turns off.

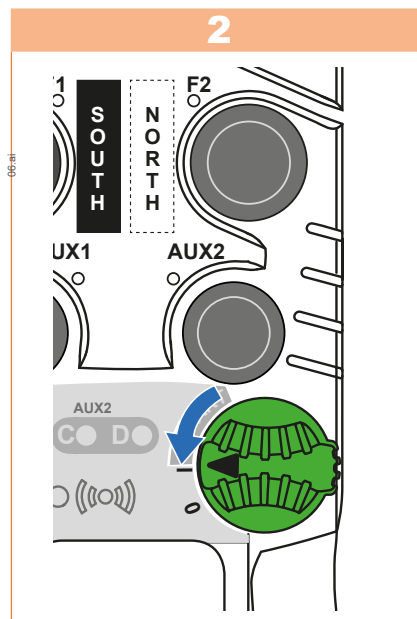

Release the **ON/OFF** switch and all other buttons: LEDs A and B indicate whether the sign of life is enabled or disabled.

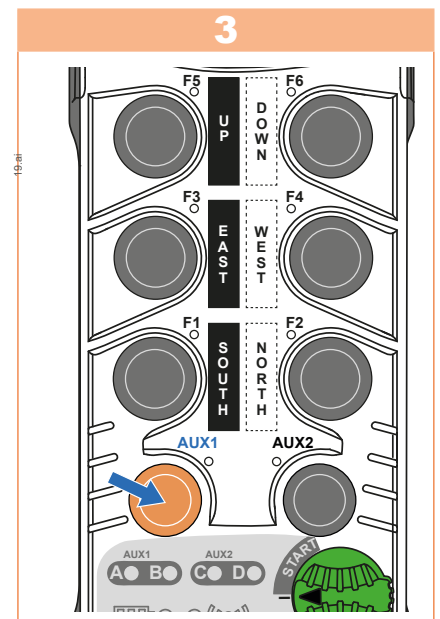

To switch from one status to another, press the **AUX1** button.

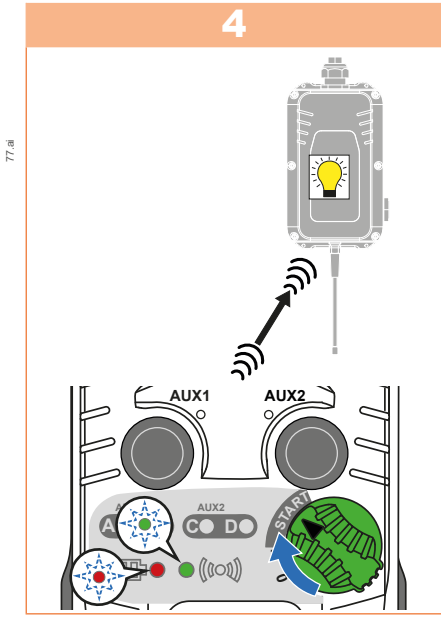

Confirm the selected status by turning the **ON/OFF** switch to **START**. During transmission:

- Battery and radio LEDs flash alternately
- Receiver light turns on.

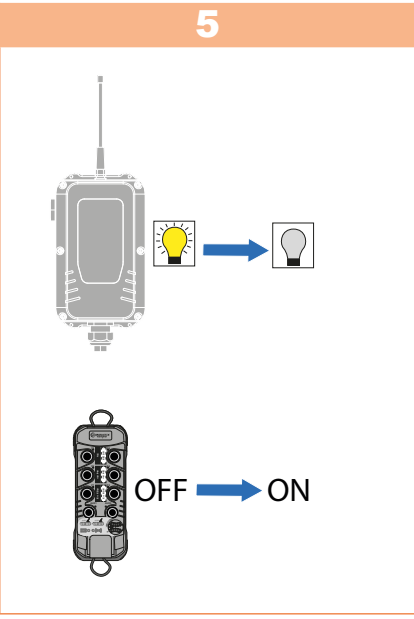

End of transmission:

- Receiver light turns off
- Transmitter shuts down and restarts.

10. Installation Instructions

10.1. Transmitter

Different button functions are identified by self-adhesive labels to be stuck on the transmitter box in the space provided for this purpose each button.

Labels are delivered in sheets to be used according to the application.



10.2. Radio Receiver Position

The receiver should be mounted in a protected place from shock and weather. The antenna should be as far away as possible from the power cables (power supply, motor, drive, etc.) but remain in an area favorable to radio reception. It must be located within sight of the operator handling the equipment. There should be no metallic masses near it.

- The antenna will be located high above the operator handling the transmitter. There should be no metal between the operator and the antenna.
- The antenna is directed towards the working areas of the transmitter (downwards in the case of a hoist).
- The correct orientation of the antenna is shown in the figure below:

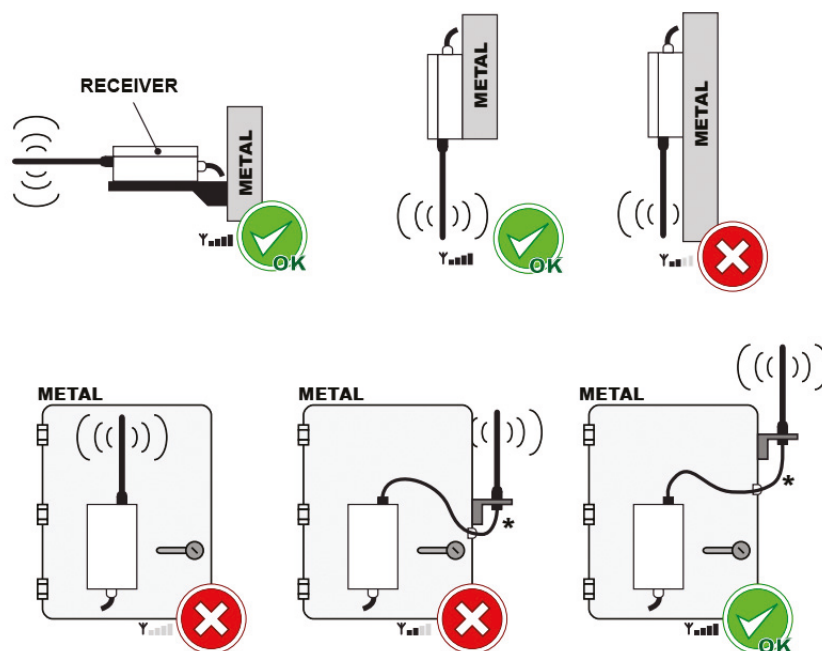

If the installation of the receiver does not allow the operator to see the antenna, it is advisable to offset the receiver antennas under the beams, and point them vertically towards the radio control area, as shown below:

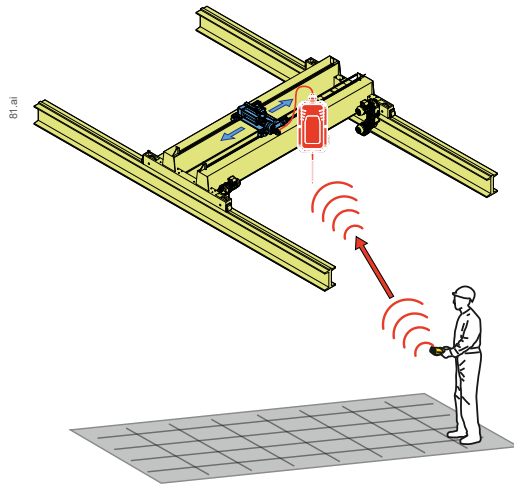

If several devices are equipped with radio controls, working in the same vicinity (e.g., in a factory), each transmitter must carry clear information that tells the operator which equipment it controls. Similarly, the operator must be able to identify the controls corresponding to the directions of movement of the equipment being steered.

10.3. Mounting the Receiver

See Retrieve mechanical plan for attaching the housing.

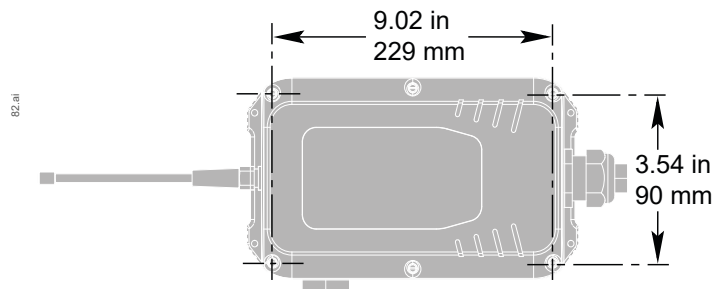

10.4. Antennas

10.4.1. Antenna Type

The receiver housing is equipped with a non-detachable antenna. However, it is possible to install a remote antenna. In this case, a BNC plug-in antenna kit must be purchased and installed (refer to Chapter [19.2](#) Accessories).

10.5. Connection

The receiver is equipped with an output cable for connecting the power supply and relay outputs.

Below, the correspondence of the strand outputs and their assignments.

Function	Relay	Fuse	Marker Diagram	Terminal Number
Power input 48-230Vac	-	FUS1	AC-1	1
Power input 48-230Vac	-	-	AC-2	2
Safety relay output 1	K14	FUS2	RS1	3
Safety relay output 2	K16	-	RS2	4
Function ON output relay	K13	-	RM	5
ON relay output	K13	-	RM	6
AUX and selection relay common	-	FUS3	COM1	7
Function relay output	K10	-	Aux 1	8
Function relay output Aux 1	K11	-	Aux 2-1	9
Function relay output Aux 2	K12	-	Aux 2-2	10
Common 2	-	FUS4	COM2	11
Function relay output F1	K1	-	F1.1	12
Function relay output F2	K2	-	F2.1	13
Function relay output F1/F2	K3	-	F1.2/F2.2	14
Common 3	-	FUS5	COM3	15
Function relay output F3	K4	-	F3.1	16
Function relay output F4	K5	-	F4.1	17
Function relay output F3/F4	K6	-	F3.2/F4.2	18
Common 4	-	FUS6	COM4	19
Function relay output F5	K7	-	F5.1	20
Function relay output F6	K8	-	F6.1	21
Function relay output F5/F6	K9	-	F5.2/F6.2	22

Wire diagram

Wire Diagram.ai

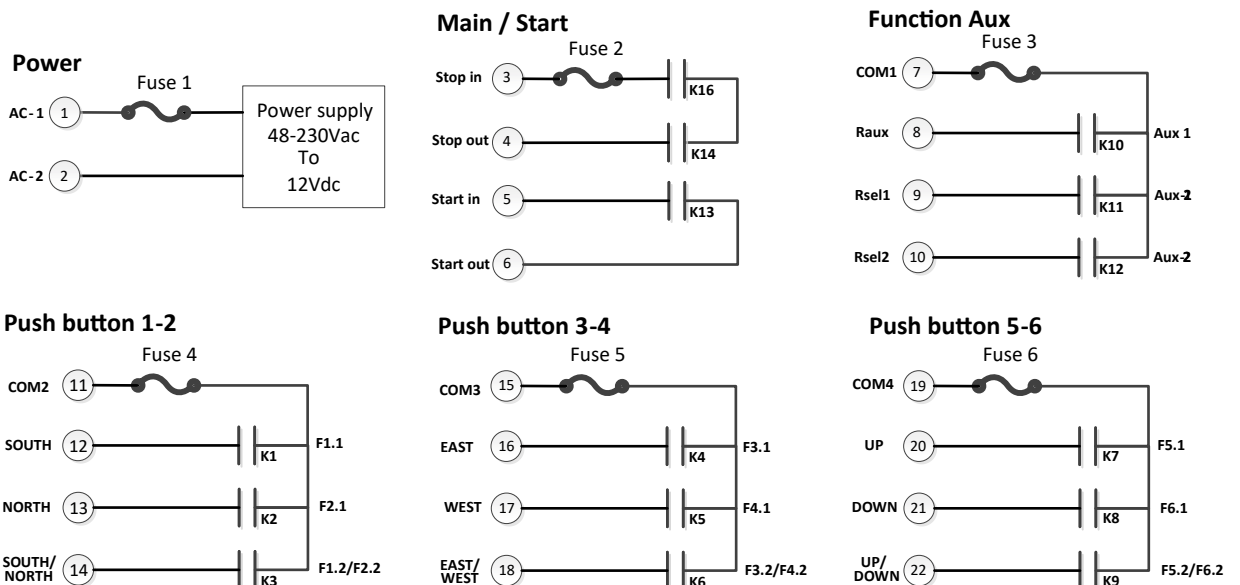

11. Maintenance

BEFORE PERFORMING ANY MAINTENANCE, TURN OFF THE POWER TO THE PRODUCT

11.1. Receiver Maintenance

The housing can only be disassembled by trained personnel in a “controlled” environment.

Parts can only be replaced with identical spare parts.

- Check the connection of the antenna; it must be clean and unoxidized.
- Check the quality of power supply and control output wiring.
- Correct operation of shutdown circuits, active.
- Condition of cover gasket, tightness of fastening screws.
- Use only non-aggressive soap-based cleaners.

11.2. Transmitter Maintenance

The transmitter housing must not be opened.

- Regularly check the condition of the transmitter, paying particular attention to the batteries in the battery compartment. If the transmitter is not used for a long period of time, it is recommended to remove the batteries.
- If any of the function button membranes or the transmitter housing gasket are damaged, the equipment should not be used until these sealing parts are replaced. Otherwise, any liquid, dust, or foreign object may damage the transmitter.
- The user's attention is drawn to the risks of using the remote control in an environment containing polymer solvents or glues that could degrade the proper functioning of the transmitter's mechanical parts.
- Clean the transmitter by removing any adhering foreign matter.
- Use only non-aggressive soap-based cleaners.

12. Warranty

All our devices are guaranteed for two years from the day of shipment.

Repairs, modifications or the replacement of a device during the warranty period shall not extend the warranty period.

Restriction:

The warranty does not cover defects resulting from:

- Transport
- Incorrect operation or failure to follow the connection diagrams during start up
- Lack of monitoring or maintenance, use not in accordance with the specifications in the technical manual and, in general, storage, operating or environmental conditions (atmospheric, chemical, electrical, mechanical or other influences) which are not suitable or not foreseen at the time of order

The warranty cannot be exercised if modifications, dismantling or additions have been made by the customer without the written consent of our Company.

The responsibility of Conductix-Wampfler during the period of warranty is limited to any material or construction defect; this includes the repair in its workshops or the free replacement of parts recognized as defective according to the expertise of its "technical services". Conductix-Wampfler cannot give right to any compensation for damages.

In the event of a dispute concerning supply or payment, THE COMMERCIAL COURT OF GRENOBLE is the only competent authority, even in the event of Appeal or of plurality of defendants.

13. Technical Specifications

13.1. Receiver

Mechanical Specifications and Environmental Resistance	
Housing Material	PA66 GF 30 (PC cover)
Housing color	Black background and translucent/transparent cover
Protection Index	IP65 (Indoor use only)
Mass	1.4kg (including cable)
Overall Dimensions	12.20 (without antenna, with PES) x 5.90 (with horn) x 3.14 in 310 (without antenna, with PES) x 150 (with horn) x 80 mm
Fastening	4x screws M3 – 229 x 90mm Possibility to add magnets with or without silent blocks
Operating Temperature	-20°C to +55°C
Storage Temperature	-20°C to +70°C
Connection	22-strands cable, section 0.75 mm ² , AWG 18 (0.8mm ² Kcmil) Length 59 in / 1.5 m
Cable Entry	PE M32 diam 17-25
Power Indicator Light	Amber LED
Radio Indicator Light	Green LED
Safety relay active indicator light	Red LED
Function indicator light	White lamp
Sound indicator	Horn 95dB
Antenna	Wire antenna protected by cable gland and plastic tube
Breathable membrane (internal anti-condensation)	Yes, Goretex
Pollution degree	2

Electrical Specifications	
Power Supply	
Supply voltage (steady state)	48 Vac to 230Vac \pm 10% - 50/60Hz
Protection	Fuse 0.5 A
Consumption	<15W
Pollution degree	2
Overvoltage category	III (MKR)
Safety relay outputs	
Number of outputs (2 relays in series)	2
Contacts	AgNi + Au
Contact Type	Guided contact relays
Break Capacity	250Vac @ 5A max (at max operating temperature) 12Vdc @ 50mA min
Max Power at $\cos \varphi = 1$	2000VA
Switching Lifespan at 230VAC, 6A, $\cos \varphi = 1$	100,000 (230Vac, 6A, $\cos\phi=1$)
Protection	Fuse 5 A (cartridge 0.2 x 0.79 in / 5 x 20 mm)
Control relay outputs	
Number of outputs	16 (3 x 3 movement +3 AUX + 1 ON)
Contacts	AgNi + Au
Contact Type	Contact relays
Break Capacity	250Vac @ 5A max (at max operating temperature) 12Vdc @ 50mA min
Max Power at $\cos \varphi = 1$	2000VA
Switching Lifespan at 230VAC, 6A, $\cos \varphi = 1$	100,000 (230Vac, 6A, $\cos\phi=1$)
Protection	4 x Fuse 5A (cartridge 0.2 x 0.79 in / 5 x 20 mm)

13.1.1. Dimensions

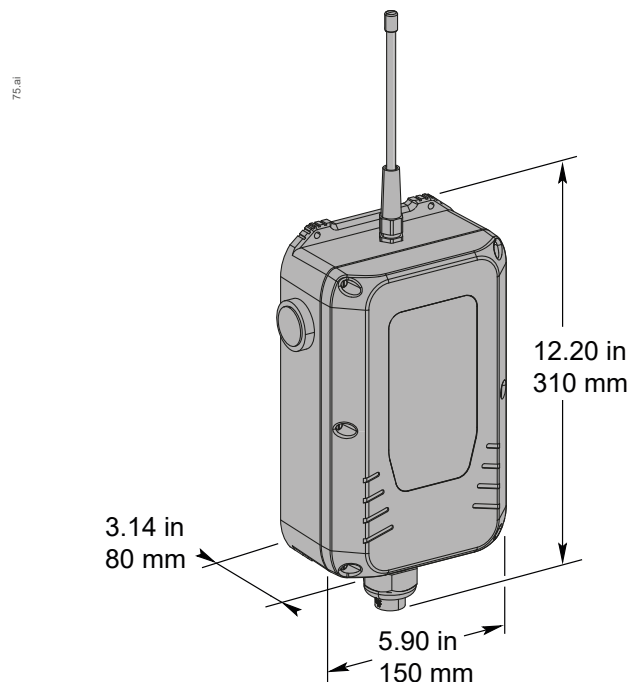

13.2. Transmitter

Mechanical Specifications and Environmental Resistance	
Housing Material	PA66 GF 30
Housing color	Orange RAL2004
Protection Index	IP65
Mass	300g max
Overall Dimensions	7.09 x 2.76 x 1.77 in 180 x 70 x 45 mm
Operating Temperature	-20°C to +50°C
Storage Temperature	-30°C to +70°C
Transport	2 strap anchor points
Protection	Foam, protective cover
Breathable membrane (internal anti-condensation)	Yes
Pollution degree	2
Overvoltage category	I (MKT)
Electrical Specifications	
Power Supply	Battery
Pollution degree	2
Overvoltage category	I
Number of function buttons	6
Number of AUX buttons	2
Battery life	100 h
Power Indicator Light	Red
Radio Indicator Light	Green
AUX position indicator 1, A and B	Orange
AUX position indicator 2, C and D	Orange

13.2.1. Dimensions

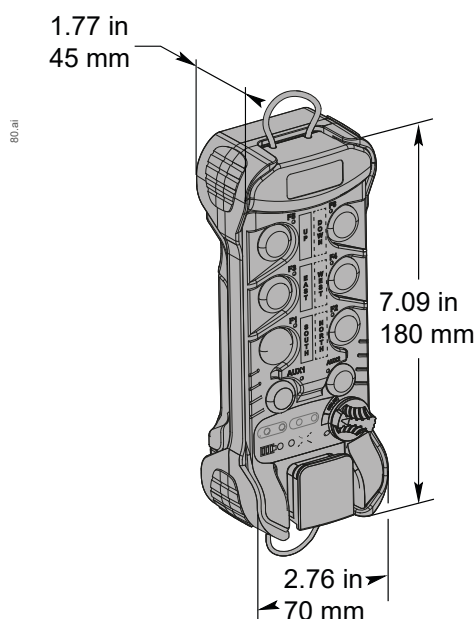

13.3. Radio

Radioelectrical Specifications (US)	
Transmission Frequency	433-440MHz
Number of Channels	92
Space Between Channels	75kHz
Receiver Sensitivity	-100dBm
Transmission Power	1mW
Modulation	FSK
Frame	Hamming 4 distance with encryption against external attacks
Medium Range*	54.7-109.4 yd / 50-100 m in industrial setting* 437.6 yd in / 400 m in open space
Antenna Output Impedance	50 Ohms
Response Time at Startup	500 ms
Command Response Time	300 ms

*The range varies according to the environmental conditions of the transmitter and receiving antenna (frames, metal walls, etc.).

13.4. Battery

Specifications		
Type	Alkaline	Nickel-Metal-Hydride
Format	LR6 (AA)	AA-NIMH
Voltage	1.5 V	1.35 V
Operating Temperature	0°C to +50°C	0°C to +40°C
Storage Temperature	-20°C to +70°C	-10°C to +60°C

14. FCC (Federal Communications Commission) Regulations

Products comply with the requirements of the Federal Communications Commission **FCC Part 15, Subpart C, Section 15.231 (b)(2) Periodic operation in the band 40.66-40.70 MHz and above 70 MHz.**

14.1. FCC (Federal Communications Commission) Regulations

Any changes or modifications to this equipment not expressly approved by JAY Electronique could result in cause harmful interference and void the FCC authorization to operate this equipment.

This equipment has been tested and found to comply with the limits for a Class A digital device, pursuant to the FCC Part 15.

These limits are designed to provide reasonable protection against harmful interference when the equipment is operated in a commercial environment.

This equipment generates, uses, and can radiate radio frequency energy and, if not installed and used in accordance with the instruction manual, may cause harmful interference to radio communications.

Operation of this equipment in a residential area is likely to cause harmful interference in which case the user will be required to correct the interference at their own expense.

This portable equipment and its antennas comply with FCC radiation exposure limits set forth for an uncontrolled environment.

To maintain compliance, follow the instructions below:

- 1. This transmitter must not be co-located or operated in conjunction with any other antenna or transmitter.
- 2. Avoid direct contact with the antenna or keep contact to a minimum when using this equipment.

Authorized Antennas: see “Antennas” chapter

Antenna Installation Requirements: See Chapter “Receiver Installation”

FCC Product ID:

FCC ID: OQMKT Transmitter

FCC ID: OQMKR Receiver

IC (Industry Canada) Regulation

This Class (A) digital apparatus meets all the requirements of the Canadian NMB-003 standard.

This portable equipment and its antennas comply with CNR102 radiation exposure limits applicable for an uncontrolled environment. To maintain compliance, follow the instructions below:

- 1. This transmitter must not be co-located or operated in conjunction with any other antenna or transmitter.
- 2. Avoid direct contact with the antenna or keep contact to a minimum when using this equipment.

This radio transmitter (IC transmitter: 3393A-KT, IC receiver: 3393A-KR depending on the model) has been approved by Industry Canada for use with the antenna types listed in the Section “Antennas”. This is the only way to ensure that the antenna will be able to operate with the same maximum allowable gain and impedance for each type of antenna listed. Antenna types not included in this list, and whose gain is greater than the maximum gain listed, are strictly prohibited for use with the transmitter.

Authorized Antennas: see “Antennas” chapter

Antenna Installation Requirements: See Chapter “Receiver Installation”

This device complies with Industry Canada’s RSS for license-exempt radio equipment.

Operation is permitted under the following two conditions:

- 1. The device must not cause interference
- 2. The user of this equipment must accept any radio interference received, even if the interference is likely to affect the operation of the equipment

Product IC:

IC transmitter: 3393A-KT

IC receiver: 3393A-KR

Transmitter RF Exposure

This device complies with the RF personal exposure requirement limit levels defined by ISDE. The unit should not be installed in close proximity to or used in conjunction with any other antenna or transmitter.

14. Réglementation FCC (Commission fédéral des communications)

Les produits sont conformes avec les exigences de la commission fédéral des communications **FCC part 15, Subpart C, Section 15.231 (b)(2) Periodic operation in the band 40.66-40.70 MHz and above 70 MHz.**

14.1. Réglementation FCC (Commission fédéral des communications)

■ Toutes modifications apportées à cet équipement non expressément approuvées par JAY Electronique peuvent causer des interférences nuisibles et annuler l'autorisation FCC d'utiliser cet équipement.

Cet équipement a été testé et déclaré conforme aux limites d'un appareil numérique de classe A, conformément à la FCC part 15.

Ces limites sont conçues pour fournir une protection raisonnable contre les interférences nuisibles lorsque l'équipement est utilisé dans un environnement commercial.

Cet équipement génère, utilise et peut émettre de l'énergie radiofréquence et, s'il n'est pas installé et utilisé conformément au manuel d'instruction, peut provoquer des interférences nuisibles aux communications radio.

Le fonctionnement de cet équipement dans une zone résidentielle est susceptible de provoquer des interférences nuisibles, auquel cas l'utilisateur devra corriger les interférences à ses propres frais.

Cet équipement portable avec ses antennes est conforme aux limites d'exposition aux rayonnements de la FCC définies pour un environnement non contrôlé.

Pour maintenir la conformité, suivez les instructions ci-dessous :

- 1. Cet émetteur ne doit pas être co-localisé ou fonctionner en conjonction avec toute autre antenne ou émetteur.
- 2. Evitez tout contact direct avec l'antenne ou gardez le contact au minimum pendant l'utilisation de cet équipement.

Antennes autorisées : voir chapitre « Antennes »

Exigences d'installation des antennes : voir chapitre « Installation du Récepteur »

FCC ID du produit :

FCC ID: Émetteur OQMKT

FCC ID: Récepteur OQMKR

Réglementation IC (Industrie Canada)

Cet appareil numérique de la classe (A) respecte toutes les exigences de la norme NMB-003 du Canada.

Cet équipement portable avec ses antennes est conforme aux limites d'exposition aux rayonnements de la CNR102 applicables pour un environnement non contrôlé. Pour maintenir la conformité, suivez les instructions ci-dessous :

- 1. Cet émetteur ne doit pas être co-localisé ou fonctionner en conjonction avec toute autre antenne ou émetteur.
- 2. Evitez tout contact direct avec l'antenne ou gardez le contact au minimum pendant l'utilisation de cet équipement.

Le présent émetteur radio (IC émetteur : 3393A-KT, IC récepteur : 3393A-KR en fonction du modèle) a été approuvé par Industrie Canada pour fonctionner avec les types d'antenne énumérés dans le chapitre « Antennes » ayant un gain admissible maximal autorisé et une impédance identique pour chaque type d'antenne indiqué.

Les types d'antenne non inclus dans cette liste, et dont le gain est supérieur au gain maximal indiqué, sont strictement interdits pour l'utilisation avec l'émetteur.

Antennes autorisées : voir chapitre « Antennes »

Exigences d'installation des antennes : voir chapitre « Installation du Récepteur »

Le présent appareil est conforme aux CNR d'Industrie Canada applicables aux appareils radio exempts de licence.

L'exploitation est autorisée aux deux conditions suivantes :

- 1. L'appareil ne doit pas produire de brouillage ;
- 2. L'utilisateur de l'appareil doit accepter tout brouillage radioélectrique subi, même si le brouillage est susceptible d'en compromettre le fonctionnement.

IC du produit :

IC émetteur : 3393A-KT

IC récepteur : 3393A-KR

Exposition RF de l'émetteur

Le présent appareil est conforme aux niveaux limites d'exigences d'exposition RF aux personnes définies par ISDE. L'appareil ne doit pas être installé à proximité ou être utilisé en conjonction avec une autre antenne ou un autre émetteur.

15. Standards and environmental specification

According to the standard:

Safety requirements for electrical equipment for measurement, control, and laboratory use;

- IEC 61010-1:2010/AMD1 :2016
- UL 61010-1:2012/R :2019-07
- CSA C22.2 No. 61010-1:2012/A1 :2018-11

Degrees of protection provided by enclosures (IP code):

- IEC 60529:1989/A1:1999

Altitude of the site of installation does not exceed 2000 m.

The relative humidity of the air does not exceed 50 % at a maximum temperature of +40°C.

Higher relative humidities may be permitted at lower temperatures, e.g. 90 % at + 20°C.

16. Recycling and Waste Management



When this device is worn, it should not be disposed of in any kind of dumping ground.

It can be taken to the specific collection centers, differentiated by local administrations, or to the distributors who take care of them.

The sorting of electronic waste avoids possible negative consequences on the environment, derived from an inappropriate elimination and allows the processing and recycling of its materials, which favors important savings in terms of energy and resources.

17. Manufacturer Information



Manufacturer and Factory:

Jay électronique
ZAC la Bâtie, rue Champrond
F38334 SAINT ISMIER Cedex

Tel: + 33 (0)4 76 41 44 00
www.jay-electronique.com

18. Compliance Statement

Product conformity statements are available at www.jay-electronique.com

19. Appendix

19.1. Radio Frequency Table

channel 1	433.1MHz	channel 32	435.425MHz	channel 63	437.75MHz
channel 2	433.175MHz	channel 33	435.5MHz	channel 64	437.825MHz
channel 3	433.25MHz	channel 34	435.575MHz	channel 65	437.9MHz
channel 4	433.325MHz	channel 35	435.65MHz	channel 66	437.975MHz
channel 5	433.4MHz	channel 36	435.725MHz	channel 67	438.05MHz
channel 6	433.475MHz	channel 37	435.8MHz	channel 68	438.125MHz
channel 7	433.55MHz	channel 38	435.875MHz	channel 69	438.2MHz
channel 8	433.625MHz	channel 39	435.95MHz	channel 70	438.275MHz
channel 9	433.7MHz	channel 40	436.025MHz	channel 71	438.35MHz
channel 10	433.775MHz	channel 41	436.1MHz	channel 72	438.425MHz
channel 11	433.85MHz	channel 42	436.175MHz	channel 73	438.5MHz
channel 12	433.925MHz	channel 43	436.25MHz	channel 74	438.575MHz
channel 13	434MHz	channel 44	436.325MHz	channel 75	438.65MHz
channel 14	434.075MHz	channel 45	436.4MHz	channel 76	438.725MHz
channel 15	434.15MHz	channel 46	436.475MHz	channel 77	438.8MHz
channel 16	434.225MHz	channel 47	436.55MHz	channel 78	438.875MHz
channel 17	434.3MHz	channel 48	436.625MHz	channel 79	438.95MHz
channel 18	434.375MHz	channel 49	436.7MHz	channel 80	439.025MHz
channel 19	434.45MHz	channel 50	436.775MHz	channel 81	439.1MHz
channel 20	434.525MHz	channel 51	436.85MHz	channel 82	439.175MHz
channel 21	434.6MHz	channel 52	436.925MHz	channel 83	439.25MHz
channel 22	434.675MHz	channel 53	437MHz	channel 84	439.325MHz
channel 23	434.75MHz	channel 54	437.075MHz	channel 85	439.4MHz
channel 24	434.825MHz	channel 55	437.15MHz	channel 86	439.475MHz
channel 25	434.9MHz	channel 56	437.225MHz	channel 87	439.55MHz
channel 26	434.975MHz	channel 57	437.3MHz	channel 88	439.625MHz
channel 27	435.05MHz	channel 58	437.375MHz	channel 89	439.7MHz
channel 28	435.125MHz	channel 59	437.45MHz	channel 90	439.775MHz
channel 29	435.2MHz	channel 60	437.525MHz	channel 91	439.85MHz
channel 30	435.275MHz	channel 61	437.6MHz	channel 92	439.925MHz
channel 31	435.35MHz	channel 62	437.675MHz		

19.2. Accessories

19.2.1. US Version

- OWE20** Neck strap included with each transmitter
- PWM111** Hand strap
- UDWR38** Receiver magnetic mounting kit
- UWE102** Shoulder strap
- PWM113** Transmitter magnetic mount
- UWE106** Transmitter belt clip
- UWE320** Transmitter protective cover
- PWM107** Transmitter belt carrying sleeve

19.2.2. External antenna option

The antenna of the receiver product is simple wire in standard version. It is possible to change this antenna by listed antennas below with an adaptor in option:

- **VUA110AH** (with 10m cable)
Type: through insulated remote, 1/2 wave, BNC connection
Approximate length: 320 mm
Required drill hole: 15mm



- **VUA103AM** (with 3m cable)
- **VUA105AM** (with 5m cable)
- Type: insulated magnetic remote, tuned, BNC connection
Approximate length: 440 mm



- **OWR02**
MMCx - BNC adapter, 10cm, to connect an additional antenna



354840C



ZAC la Bâtie, rue Champrond
F38334 SAINT ISMIER Cedex

Tel: +33 (0)4 76 41 44 00

Conductix-Wampfler
10102 F street
Omaha, NE 68127-1104 USA
Tel no: 1-800-521-4888

www.conductix.us/en